

## Operating Instructions

---

SIP Cordless Phone

Model No. **KX-TGP600**

SIP Cordless Handset

Model No. **KX-TPA60**

SIP Wireless Desk Phone

Model No. **KX-TPA65**

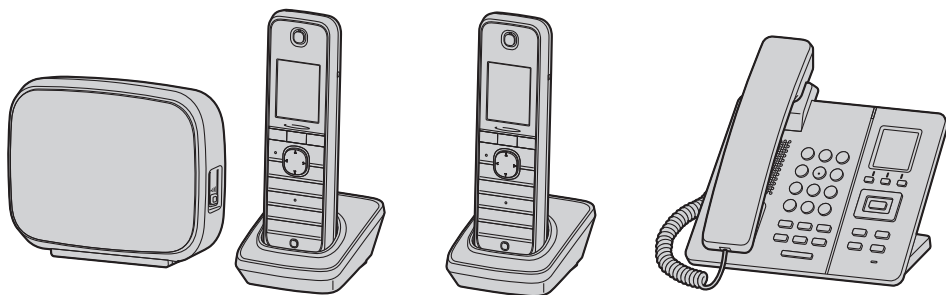

**KX-TGP600**

**KX-TPA60**

**KX-TPA65**

Thank you for purchasing this Panasonic product.

Please read this manual carefully before using this product and save this manual for future use.

Please use only the batteries provided and charge the batteries for about 6 hours before using the handset for the first time. For details, see “Charging the Batteries”, Page 82 in this manual.

### Note

- In this manual, the suffix of each model number is omitted unless necessary.
- The illustrations such as some keys may differ from the appearance of the actual product.
- Certain products and features described in this document may not be available in your country or area. Contact your phone system dealer/service provider.
- The contents and design of the software are subject to change without notice.

# Introduction

---

## Outline

This manual describes information about the installation and operation of KX-TGP600, KX-TPA60 and KX-TPA65.

## Related Documentation

- **Quick Start Guide**

Describes basic information about the installation and safety precautions to prevent personal injury and/or damage to property.

- **Administrator Guide**

Describes detailed information about the configuration and management of this unit.  
This guide describes information about the KX-TGP600 only.

Manuals and supporting information are provided on the Panasonic Web site at:

<http://www.panasonic.net/pcc/support/sipphone/>

## For Future Reference

Record the information in the space below for future reference.

## Note

- The serial number of this product may be found on the labels affixed to the following places:
  - Base unit (KX-TGP600): the back of the unit
  - Handset (KX-TPA60): the inside of the battery compartment on the back of the handset
  - Charger (KX-TPA60): the bottom of the charger
  - Desk phone (KX-TPA65): the bottom of the phone

You should note the serial numbers of these units in the space provided and retain this manual as a permanent record of your purchase to aid in identification in the event of theft.

MODEL NO.	_____
SERIAL NO.	_____
DATE OF PURCHASE	_____
NAME OF DEALER	_____
DEALER'S ADDRESS	_____ _____ _____
DEALER'S TEL. NO.	_____

**Important Information**

Important Information .....4  
 For Users in European Countries .....5  
 For Users in the United Kingdom .....5  
 For Users in Australia and the United Kingdom .....6  
 For Users in New Zealand .....6  
 For Users in the United States .....6  
 For Users in Canada .....8  
 For Best Performance .....10  
 Battery Information (KX-TPA60 only) .....11

**Before Operating the Telephones**

Before Operating the Telephones .....13  
 Accessory Information .....15  
 Location of Controls .....18  
 The Display and Icons .....29  
 Adjusting the Volume .....40  
 Incoming/Outgoing Call Log .....41  
 Parallel Mode (KX-TPA65 only) .....42  
 Setting the Password .....43  
 Key Lock .....43  
 Selecting the Display Language .....44  
 Entering Characters .....44  
 Power On/Off (KX-TPA60 only) .....45  
 Power Save Mode .....45  
 Basic Operation .....45

**Making Calls**

Making Calls .....47  
 Basic Calling .....47  
 Easy Dialing .....48  
 Making a Multicast Voice Paging Call .....51

**Receiving Calls**

Receiving Calls .....52  
 Answering Calls .....52  
 Hands-free Mode .....53  
 Answering an Intercom Call .....54  
 Silent Mode .....54  
 Noise Reduction/Voice Clarity (KX-TPA60 only) .....54

**During a Conversation**

During a Conversation .....56

**Before Leaving Your Desk**

Call Forwarding/Do Not Disturb .....61  
 Listening to Voice Mail Messages (when connected to the KX-TGP600 only) .....61

**Using the Phonebook**

Using the Phonebook .....62  
 Using the Handset Phonebook .....63

Using the Base Unit Phonebook (when connected to a base unit other than the KX-TGP600 only) .....69  
 Using the Remote Phonebook (when connected to the KX-TGP600 only) .....71

**Customizing the Telephone**

Customizing the Telephone .....72

**Installation and Setup**

Installation and Setup .....79  
 Connections .....81  
 Updating the Software .....85  
 Registering/Deregistering a Handset/Desktop Phone to the KX-TGP600 .....85

**Appendix**

Appendix .....88

# Important Information

---

## Data Security

- This telephone communicates using digital signals that are difficult to intercept. However, it is possible that the signals could be intercepted by a third party.
- To avoid unauthorized access to this product:
  - Keep the password (e.g., PIN for registration) secret.
  - Change the default password.
  - Set a password that is random and cannot be easily guessed.
  - Change the password regularly.
- This product can store your private/confidential information. To protect your privacy/confidentiality, we recommend that you erase the information such as the phonebook or call log from the memory before you dispose of, transfer or return the product, or have the product repaired.
- Set the password when you register the handset/desk phone to the base unit.
- It is recommended that you lock the phonebook or call log to prevent stored information from being leaked when you carry the handset or if the handset is lost.

---

## Information for Users on Collection and Disposal of Old Equipment and used Batteries

---

### Information for Users on Collection and Disposal of Old Equipment and used Batteries



These symbols on the products, packaging, and/or accompanying documents mean that used electrical and electronic products and batteries should not be mixed with general household waste.

For proper treatment, recovery and recycling of old products and used batteries, please take them to applicable collection points, in accordance with your national legislation and the Directives 2002/96/EC and 2006/66/EC.

By disposing of these products and batteries correctly, you will help to save valuable resources and prevent any potential negative effects on human health and the environment which could otherwise arise from inappropriate waste handling.

For more information about collection and recycling of old products and batteries, please contact your local municipality, your waste disposal service or the point of sale where you purchased the items.

Penalties may be applicable for incorrect disposal of this waste, in accordance with national legislation.

#### For business users in the European Union

If you wish to discard electrical and electronic equipment, please contact your dealer or supplier for further information.



#### Information on Disposal in other Countries outside the European Union

These symbols are only valid in the European Union. If you wish to discard these items, please contact your local authorities or dealer and ask for the correct method of disposal.



#### Note for the battery symbol (bottom two symbol examples):

This symbol might be used in combination with a chemical symbol. In this case it complies with the requirement set by the Directive for the chemical involved.

Cd

## **For Users in European Countries**

The following declaration is applicable to KX-TGP600CE/KX-TGP600UK/KX-TPA60CE/  
KX-TPA60UK/KX-TPA65CE/KX-TPA65UK/KX-TPA65X only

**CE 0470**

This device is a DECT Portable station operating in the frequency band of 1880 MHz to 1900 MHz.  
The usage of this device is generally allowed in all EU countries.

Panasonic System Networks Co., Ltd. declares that this equipment is in compliance with the essential requirements and other relevant provisions of Radio & Telecommunications Terminal Equipment (R&TTE) Directive 1999/5/EC.

Declarations of Conformity for the relevant Panasonic products described in this manual are available for download by visiting:

<http://www.ptc.panasonic.eu>

Contact to Authorized Representative:  
Panasonic Testing Center  
Panasonic Marketing Europe GmbH  
Winsbergring 15, 22525 Hamburg, Germany

### **Ecodesign information**

Ecodesign information under EU Regulation (EC) No.1275/2008 amended by (EU) Regulation No. 801/2013.

=====

Please visit here: [www.ptc.panasonic.eu](http://www.ptc.panasonic.eu)

click [Downloads]

→ Energy related products information (Public)

=====

Power consumption in networked standby and guidance are mentioned in the web site above.

---

## **For Users in the United Kingdom**

- This unit is designed to be installed under controlled conditions of ambient temperature and a relative humidity.
- Avoid installing the unit in damp or humid environments, such as bathrooms or swimming pools.
- 999 and 112 can be dialed on the product after accessing the outside line for the purpose of making outgoing calls to the BT emergency (999) and (112) services.

The method for accessing an outside line differs depending on the SIP server. For details, confirm the features of the SIP server.

### For Users in Australia and the United Kingdom

- This unit is capable of being used in conjunction with hearing aids fitted with inductive coil pick-ups. The handset should be held as for normal conversation. For operation, the hearing aid should be set to its "T" position or as directed in the operating instructions for the hearing aid.
- This unit is designed to aid the visually handicapped to locate dial keys and buttons.



---

### For Users in New Zealand

- This equipment shall not be set to make automatic calls to the Telecom '111' Emergency Service.

#### PTC General Warning

- The grant of a Telepermit for any item of terminal equipment indicates only that Telecom has accepted that the item complies with minimum conditions for connection to its network. It indicates no endorsement of the product by Telecom, nor does it provide any sort of warranty. Above all, it provides no assurance that any item will work correctly in all respects with another item of Telepermitted equipment of a different make or model, nor does it imply that any product is compatible with all of Telecom's network services.

#### The Use of IP Networks through the PSTN

- Internet Protocol (IP) by its nature introduces delay into speech signals as each data packet is formulated and addressed. Telecom Access Standards recommends that suppliers, designers and installers using this technology for calls to or from the PSTN refer to ITU E Model requirements in the design of their networks. The overall aim is to minimize delay, distortion and other transmission impairments, particularly for those calls involving cellular and international networks, which already suffer extensive delay.

#### Echo cancellation

- Echo cancelers are not normally required in the Telecom PSTN because geographic delays are acceptable where CPE return loss is maintained within Telepermit limits. However, those private networks making use of Voice over IP technology are required to provide echo cancellation for all voice calls. The combined effect of audio/VoIP conversion delay and IP routing delay can cause the echo cancellation time of  $\geq 64$  ms to be required.

#### Important Notice

- Under power failure conditions this appliance may not operate. Please ensure that a separate telephone, not dependent on local power, is available for emergency use.
- No "111" or other calls can be made from this device during a mains power failure.

---

### For Users in the United States

#### FCC and Other Information

Privacy of communications may not be ensured when using this phone.

#### FCC RF Exposure Warning:

- This product complies with FCC radiation exposure limits set forth for an uncontrolled environment.
- To comply with FCC RF exposure requirements, the base unit and KX-TPA65 must be installed and operated 20 cm (8 inches) or more between the product and all person's body.
- This product may not be collocated or operated in conjunction with any other antenna or transmitter.

- The handset may be carried and operated with only the specific provided belt-clip. Other non-tested belt-clips or similar body-worn accessories may not comply and must be avoided.

FCC ID can be found inside the battery compartment or on the bottom of the units.

### Note

- This equipment has been tested and found to comply with the limits for a Class B digital device, pursuant to Part 15 of the FCC Rules. These limits are designed to provide reasonable protection against harmful interference in a residential installation. This equipment generates, uses, and can radiate radio frequency energy and, if not installed and used in accordance with the instructions, may cause harmful interference to radio communications. However, there is no guarantee that interference will not occur in a particular installation. If this equipment does cause harmful interference to radio or television reception, which can be determined by turning the equipment off and on, the user is encouraged to try to correct the interference by one or more of the following measures:
  - Reorient or relocate the receiving antenna.
  - Increase the separation between the equipment and receiver.
  - Connect the equipment to an outlet on a circuit different from that to which the receiver is connected.
  - Consult the dealer or an experienced radio/TV technician for help.

This device complies with Part 15 of the FCC Rules. Operation is subject to the following two conditions:

(1) this device may not cause harmful interference, and (2) this device must accept any interference received, including interference that may cause undesired operation.

### WHEN PROGRAMMING EMERGENCY NUMBERS AND/OR MAKING TEST CALLS TO EMERGENCY NUMBERS:

1. Remain on the line and briefly explain to the dispatcher the reason for the call before hanging up.
2. Perform such activities during off-peak hours, such as early morning or late evening.

### CAUTION

Any changes or modifications not expressly approved by the party responsible for compliance could void the user's authority to operate this product.

### Hearing Aid Compatibility

This telephone provides magnetic coupling for hearing aids as defined by the FCC in 47 CFR Section 68.316. Use only handsets or other acoustic devices with this equipment that are compliant with the hearing aid compatibility requirements of FCC Part 68.

When you hold the phone to your ear, noise might be heard in your Hearing Aid. Some Hearing Aids are not adequately shielded from external RF (radio frequency) energy. If noise occurs, use an optional headset accessory or the speakerphone option (if applicable) when using this phone. Consult your audiologist or Hearing Aid manufacturer about the availability of Hearing Aids which provide adequate shielding to RF energy commonly emitted by digital devices.

### Compliance with TIA-1083 standard:



Telephone handsets identified with this logo have reduced noise and interference when used with T-Coil equipped hearing aids and cochlear implants.

### For Product Service

- Call 1-800-211-PANA (7262) for the location of your nearest authorized service center.
  - Panasonic's e-mail address for customer inquiries:  
consumerproducts@panasonic.com
- For customers in the USA and Puerto Rico ONLY.

- This cordless telephone is designed for use in the United States of America. Sale or use of this product in other countries may violate local laws.
- Ce téléphone sans fil est conçu pour être utilisé aux États-Unis d'Amérique. La vente ou l'emploi de cet appareil dans certains autres pays peut constituer une infraction à la législation locale.
- Este teléfono sin cordón fue elaborado para su uso en los Estados Unidos de América. La venta o el empleo de este producto en ciertos países puede constituir una violación de la legislación local.
- このコードレス電話機は、日本国外での使用を目的として設計されており、日本国内での使用は法律違反となります。従って、当社では日本国内においては原則として修理などのサービスは致しかねます。

---

## For Users in Canada

### Industry Canada Notices and Other Information

This product meets the applicable Industry Canada technical specifications.

#### Note

- This device complies with Industry Canada licence-exempt RSS standard(s). Operation is subject to the following two conditions: (1) this device may not cause interference, and (2) this device must accept any interference, including interference that may cause undesired operation of the device.
- Privacy of communications may not be ensured when using this phone.
- Some wireless telephones operate at frequencies that may cause interference to nearby TVs and VCRs. To minimize or prevent such interference, the wireless telephone should not be placed near, or on top of, a TV or VCR. If interference is experienced, move the wireless telephone farther away from the TV or VCR. This will often reduce, or eliminate, interference.
- This transmitter must not be co-located or operated in conjunction with any other antenna or transmitter.
- This Class B digital apparatus complies with Canadian ICES-003.

#### CAUTION

Any changes or modifications not expressly approved by the party responsible for compliance could void the user's authority to operate this product.

#### RF Exposure Warning:

- This product complies with IC radiation exposure limits set forth for an uncontrolled environment.



- To comply with IC RF exposure requirements, the base unit and KX-TPA65 must be installed and operated 20 cm (8 inches) or more between the product and all person's body.
- This product may not be collocated or operated in conjunction with any other antenna or transmitter.
- The handset may be carried and operated with only the specific provided belt-clip. Other non-tested belt-clips or similar body-worn accessories may not comply and must be avoided.

### Compliance with TIA-1083 standard:



Telephone handsets identified with this logo have reduced noise and interference when used with T-Coil equipped hearing aids and cochlear implants.

# For Best Performance

### Operating Range

- The range of operation depends on the topography of your office, weather, or usage conditions, because signals are transmitted between the base unit and the handset/desk phone by radio waves.
- Normally, you get greater range outdoors than indoors. If there are obstacles such as walls, noise may interfere with your telephone calls. In particular, high metal shelves or reinforced concrete walls will restrict your operating range.
- A handset/desk phone may not work when it is too far from the base unit depending on the structure of the building.
- We strongly suggest you hold the bottom half of the handset to ensure better call quality. Because, the antenna is located in the upper half of the handset (KX-TPA60 only).

### Noise

Occasional noise or interference may occur due to electromagnetic radiation from objects such as refrigerators, microwave ovens, faxes, TVs, radios, or personal computers. If noise disturbs your telephone calls, keep the handset/desk phone away from these electrical appliances.

### Environment

- Keep the product away from heating appliances and devices that generate electrical noise, such as fluorescent lamps and motors. These noise sources can interfere with performance of the product.
- Do not place the product in rooms where the temperature is less than 0 °C (32 °F) or greater than 40 °C (104 °F).
- To avoid damage, charge the battery only in temperatures ranging from 5 °C (41 °F) to 40 °C (104 °F).
- Allow 10 cm (3–15/16 in) clearance around the product for proper ventilation.
- Avoid environments with excessive smoke, dust, moisture, mechanical vibration, shock, or direct sunlight.
- The apparatus is designed to be installed and operated under controlled conditions of ambient temperature and a relative humidity.

### Routine Care

- Unplug the AC adaptor from the AC outlet and disconnect the Ethernet cable before cleaning.
- Wipe the product with a soft cloth.
- Do not clean the product with abrasive powder or with chemical agents such as benzine or thinner.
- Do not use liquid cleaners or aerosol cleaners.
- Clean the terminal of the charger periodically.

### Placement

- Do not place heavy objects on top of the product.
- Care should be taken so that objects do not fall onto, and liquids are not spilled into, the product.
- Place the charger on a flat surface.
- Place the KX-TPA65 in a location where the Signal Strength Indicator shows either Medium ("📶") or Strong ("📶").

## Battery Information (KX-TPA60 only)

After batteries are fully charged (at 25 °C [77 °F]):

Operation	Operating Time
While Talking (Backlight off*1, Narrowband Mode)	Up to about 11 h
While Talking (Backlight on*2, Wideband Mode)	Up to about 8 h
While not in use (Standby)	Up to about 200 h

\*1 When the "Talking" setting of "Backlight" is set to "Off". For details, see "Display Option", Page 95.

\*2 When the "Talking" setting of "Backlight" is set to "On". For details, see "Display Option", Page 95.

- Operating time may be shorter than listed above depending on usage conditions and ambient temperature.
- The batteries will drain slowly even while the handset is turned off.
- The handset can receive calls while charging.
- Battery consumption increases when the handset is out of range (if  flashes, turn the handset off).
- **Clean the handset and the charger contacts with a soft, dry cloth once a month. Clean more often if the unit is subject to grease, dust or high humidity.** Otherwise the batteries may not charge properly.

### Low Battery Warning

The batteries need to be charged in the following situations:

- The battery level indicator displays as empty ("") and the alarm sounds\*1.
- "Charge Battery" is displayed. In this situation, the handset cannot be operated.

\*1 If the low battery warning occurs during a conversation, after 1 minute, the conversation will be disconnected, and after 1 more minute, the handset will turn off.

### Replacing the Batteries

If the battery level indicator displays as empty ("") after using the phone for a short time, even when the batteries have been fully charged, the batteries should be replaced.

Before replacing the batteries, make sure the low battery warning is displayed, then turn off the power to prevent memory loss. Replace the batteries and charge the new batteries for about 6 hours.

If you replace the batteries before the low battery warning appears, the battery strength icon may display an incorrect reading. In this case, use the handset as normal with the new batteries installed.

When the low battery warning is displayed, charge the batteries for about 6 hours. The battery strength icon will then display the correct reading. To install the batteries, see "Battery Installation", Page 82.

- Please use AAA Ni-MH 1.2 V, 630 mAh batteries only. (Contact your phone system dealer/service provider.)
- There is a danger of explosion if the batteries are incorrectly replaced.



(For the United States and Canada only)

Nickel metal hydride batteries that are recyclable power the product you have purchased. Please call 1-800-8-BATTERY for information on how to recycle these batteries.

## ***Important Information***

---

### **Important Notice Concerning the Correct Use and Charging of Ni-MH Batteries**

Batteries, due to their construction, undergo some wear and tear. The lifetime of batteries also depends on correct maintenance. Charging and discharging are the most important factors. You should take notice of the following to maintain the life of the batteries as long as possible.

Ni-MH batteries have a kind of memory, the "memory effect". If fully charged batteries are used several times only for 15 minutes in the handset and then recharged, the capacity of the batteries will be reduced to 15 minutes due to the memory effect. Therefore you should discharge the batteries completely, i.e. use them in the handset until the battery level indicator displays as empty ("🔋"). Then recharge them as described in the manual. After the memory effect has occurred, it is possible to achieve almost complete capacity of the Ni-MH batteries by charging and discharging several times one after another. Ni-MH batteries can also self-discharge. This self-discharge depends on the ambient temperature. At temperatures under 0 °C (32 °F), the self-discharge will be the lowest. High humidity and high temperatures support the self-discharge. Also long-term storage will lead to self-discharge.

### **CAUTION**

RISK OF EXPLOSION IF BATTERIES ARE REPLACED BY AN INCORRECT TYPE. DISPOSE OF USED BATTERIES ACCORDING TO THE INSTRUCTIONS.

## Before Operating the Telephones

### System Overview

#### <When the base unit is a KX-TGP600>

The KX-TGP600 is a SIP Cordless Phone, which consists of a base unit, a cordless handset and a wireless desk phone, and has the following features. The handset is the same as the KX-TPA60 and the desk phone is the same as the KX-TPA65.

- Expandable to cordless handsets/desk phones [KX-TPA60, KX-TPA65, KX-UDT\*<sup>1</sup> series (except for KX-UDT111)].  
Up to 8 phones in total.
- Up to 8 simultaneous calls (Narrowband mode), or up to 4 simultaneous calls (Wideband mode)
- High quality sound using noise reduction and error correction technology
- You can increase the signal range of the base unit by using a KX-A406.

#### Note

- If you will connect a KX-UDT\*<sup>1</sup> series handset (except for KX-UDT111) to the KX-TGP600, first download the firmware from the following web site and update the KX-TGP600. Then, when you register a KX-UDT series handset to the KX-TGP600, the handset will be updated automatically. However, there are some differences in the functionality between the KX-TPA60/KX-TPA65 and the KX-UDT series handsets. For details, refer to the following web site.  
<http://www.panasonic.net/pcc/support/sipphone/>  
"Download" → "KX-TGP600 series"

\*1 For KX-UDT series, Software File Version 06.000 or later

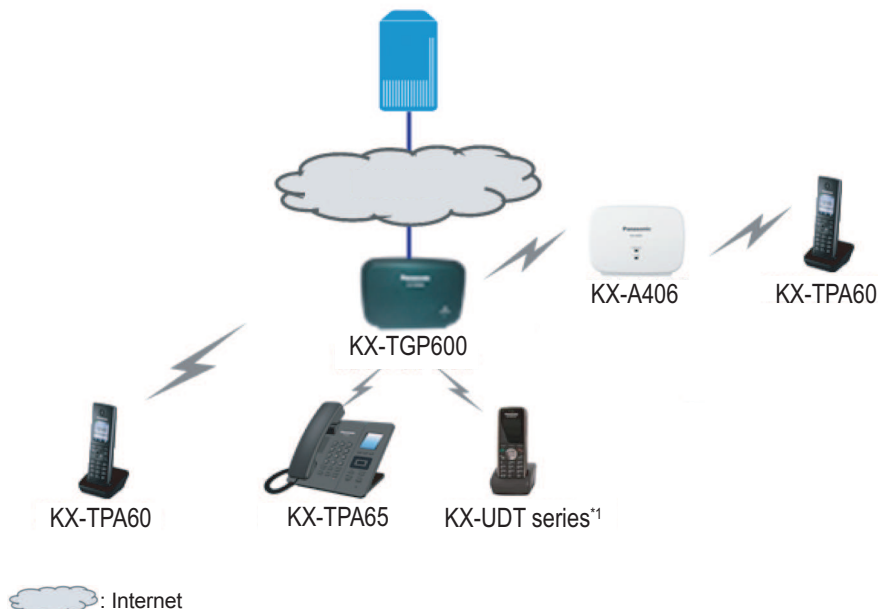

## Before Operating the Telephones

---

### <When the base unit is not a KX-TGP600>

The KX-TPA60 and KX-TPA65 support the CAT-iq (Cordless Advanced Technology-internet and quality) 2.0 standard and can be connected and used with any base unit that supports this standard. This manual describes how to connect to a base unit other than the KX-TGP600, but the availability of certain features, and the specifications of certain settings and operations will depend on the base unit being used.

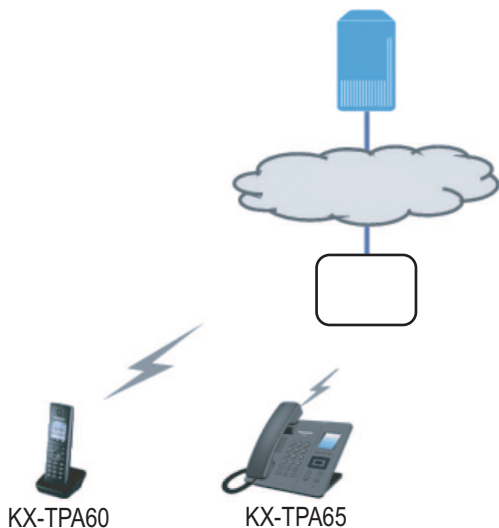







 : Internet

 : Base unit other than KX-TGP600

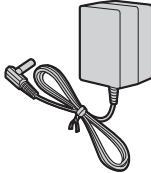
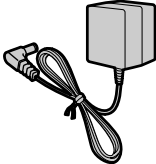
## Accessory Information

### Included Accessories

#### KX-TGP600

AC adaptor for Base unit: 1		
 <p>DC Output: 6.5 V</p>	<b>Model No.</b>	<b>Part No.</b>
	KX-TGP600/KX-TGP600C/ KX-TGP600LA	PQLV219
	KX-TGP600AL	PQLV219AL
	KX-TGP600A01/ KX-TGP600CE/KX-TGP600RU	PQLV219CE
	KX-TGP600LC	PQLV219BX
	KX-TGP600UK	PQLV219E
AC adaptor for Charger: 1*1		
 <p>DC Output: 5.5 V</p>	<b>Model No.</b>	<b>Part No.</b>
	KX-TPA60/KX-TPA60C/ KX-TPA60LA	PNLV226
	KX-TPA60AL	PNLV226AL
	KX-TPA60CE/KX-TPA60RU	PNLV226CE
	KX-TPA60LC	PNLV226BX
	KX-TPA60UK	PNLV226E
Charger: 1	Batteries*2: 2	Belt Clip: 1
		
Ethernet Cable: 1	Screws: 2 Washers: 2	
		

\*1 The AC adaptor comes attached to the charger.

\*2 Rechargeable AAA Ni-MH 1.2 V, 630 mAh batteries

## Before Operating the Telephones

### KX-TPA60

AC adaptor for Charger: 1

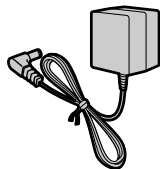

Model No.	Part No.
KX-TPA60/KX-TPA60C/ KX-TPA60LA	PNLV226
KX-TPA60AL	PNLV226AL
KX-TPA60CE/KX-TPA60RU	PNLV226CE
KX-TPA60LC	PNLV226BX
KX-TPA60UK	PNLV226E

DC Output: 5.5 V

Charger: 1



Batteries\*1: 2



Belt Clip: 1



\*1 Rechargeable AAA Ni-MH 1.2 V, 630 mAh batteries

### KX-TPA65

AC adaptor for Desk phone: 1

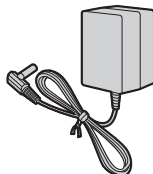

Model No.	Part No.
KX-TPA65/KX-TPA65C/ KX-TPA65LA	PQLV219
KX-TPA65AL	PQLV219AL
KX-TPA65CE/KX-TPA65RU	PQLV219CE
KX-TPA65LC	PQLV219BX
KX-TPA65UK	PQLV219E

DC Output: 6.5 V

Handset Cord: 1



Handset: 1

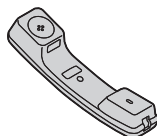

Stand: 1

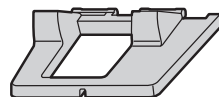

### Note

**For users in the United States only**

To order accessories, call toll-free **1-800-332-5368**.



---

## Optional Accessories

---

### KX-TPA65

Item	Model No.
Wall mount kit	<b>KX-TPA65/KX-TPA65C:</b> KX-A440  <b>KX-TPA65AL/KX-TPA65CE/KX-TPA65LA/KX-TPA65LC/ KX-TPA65RU/KX-TPA65UK:</b> KX-A440X

## Location of Controls

### Base Unit (KX-TGP600)

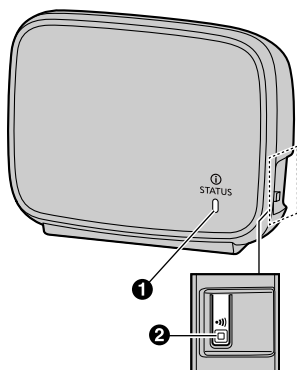

#### 1 Status Indicator

Status		Meaning
Color	Light pattern	
Green	On	<ul style="list-style-type: none"><li>• The base unit is connected to the Internet. The startup process is complete and you may now make and receive internet calls.</li></ul>
	Slow Flashing	<ul style="list-style-type: none"><li>• The base unit is being used for a call.</li><li>• The base unit is downloading data. Do not disconnect the Ethernet cable or AC adaptor from the base unit until the STATUS indicator stops flashing and lights in steady green.</li></ul>
	Quick Flashing	<ul style="list-style-type: none"><li>• The handset/desk phone is busy.</li></ul>
Red	On	<ul style="list-style-type: none"><li>• When the base unit is turned on, the STATUS indicator lights in red for about 40 seconds.</li></ul>
	Slow Flashing	<ul style="list-style-type: none"><li>• The base unit is registering a handset/desk phone.</li></ul>
	Quick Flashing	<ul style="list-style-type: none"><li>• The base unit is paging handsets/desk phones (by using the handset locator button).</li></ul>

Amber	On	<ul style="list-style-type: none"> <li>● The base unit's IP address may conflict with the IP addresses of other devices on your local network. Contact your administrator for further information.</li> </ul>
	Slow Flashing	<ul style="list-style-type: none"> <li>● The base unit is obtaining an IP address or is obtaining configurations. Please wait.</li> <li>● The base unit is registering with your phone system. Please wait</li> <li>● If the STATUS indicator continues flashing, check the following:                             <ul style="list-style-type: none"> <li>– Network settings may not be correct. Contact your administrator.</li> <li>– Many installation issues can be resolved by resetting all the equipment. First, shut down your modem, router, hub, base unit, and computer. Then turn the devices back on one at a time in this order: modem, router, hub, base unit, computer.</li> <li>– If you cannot access Internet Web pages using your computer, check to see if your phone system is having connection issues in your area.</li> <li>– For more troubleshooting help, contact your administrator.</li> </ul> </li> </ul>
	Quick Flashing	<ul style="list-style-type: none"> <li>● Unplug the base unit's AC adaptor to reset the unit, then reconnect the AC adaptor. If the STATUS indicator is still flashing rapidly, there may be a problem with the base unit hardware. Contact your phone system dealer/ service provider.</li> </ul>
Slow switching (Red→Green→Amber→Off)		The base unit is in maintenance mode. Turn the base unit off and then back on again.
Quick switching (Red→Green→Amber→Off)		The base unit is restarting. Wait a moment.
Off	—	<ul style="list-style-type: none"> <li>● The base unit power is off.</li> <li>● The Ethernet cable is not connected properly. Connect it.</li> <li>● Your network devices (hub, router, etc.) are turned off. Check the LEDs for the link status of the devices.</li> </ul>

**Note**

- The indicator flashing patterns are as follows:
  - Slow Flashing: 60 times per minute
  - Quick Flashing: 240 times per minute

**② Handset locator button**

You can locate a misplaced handset/desk phone by paging it.

If you press the button again, or after 60 seconds have passed, the page to the handset/desk phone will be stopped.

You can also register the handset/desk phone to the base unit by pressing and holding the button for about 3 seconds.

For details, see "Handset/desk phone registration using the base unit", Page 85.

# Before Operating the Telephones

## Handset (KX-TPA60)

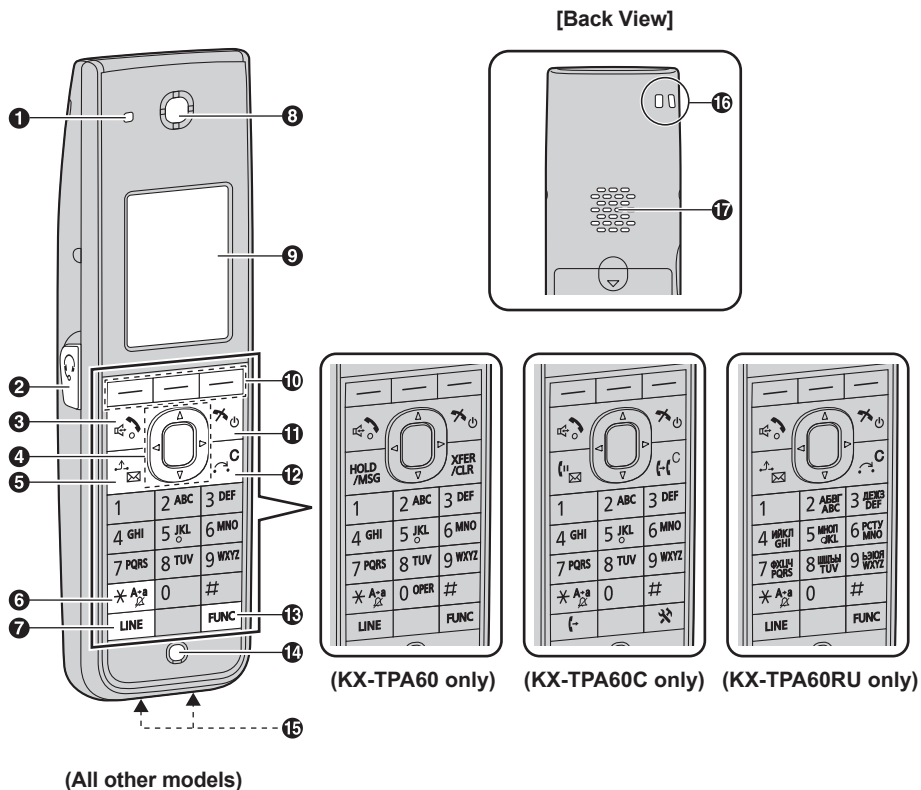

### 1 Ringer/Charge/Message Indicator

Status		Meaning
Color	Light pattern	
Red	On	Charging
	Slow Flashing	There is a new missed call or voice mail.
	Quick Flashing	Receiving a call
Off	—	Fully charged or the handset is not connected to the charger.

**2 Headset Jack**

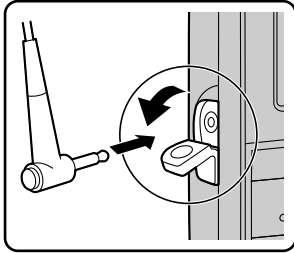

The headsets can be used with this unit. (Not all operations with the headsets can be guaranteed.) For up-to-date information about headsets that have been tested with this unit, refer to the following web sites:

<http://www.panasonic.net/pcc/support/sipphone/>

**3  (TALK/Speakerphone) Key**

Used to make or answer calls, or toggle between Receiver mode and Hands-free mode during a conversation. During a conversation using a headset, Hands-free mode does not work.

**4 Navigator Key**

The Navigator Key includes four arrow keys and a center key. The arrow keys are used to adjust the ringer/receiver volume or move the cursor to select an item. The center key is used to confirm a selection. If in standby mode, pressing the keys perform the following functions:

LEFT (◀) → Used to display the Incoming call log.\*1

UP (▲) → Used to adjust the ringer volume.

RIGHT (▶) → Used to open the phonebook.\*1

DOWN (▼) → Used to display the Outgoing call log.

CENTER → Used to display the Menu.

In this manual, when a procedure instructs you to "press **OK**", you can also press the **[CENTER]** key to confirm the selection.

\*1 When the BroadCloud (Presence) feature is enabled, the phone will operate as follows. Contact your administrator for further information.

LEFT: Used to display Presence.

RIGHT: Used to display Favorites.

**5  /  / [HOLD/MSG] Key**

During talking, used to place a call on Hold. In standby mode, used to retrieve a call on hold if there is one, or used to access your voice mailbox if no call is on hold.

**6  (Silent Mode) Key**

Used to turn Silent Mode on or off when pressed for more than 2 seconds in standby mode. For details, see "Silent Mode", Page 54.

**7  / [LINE] Key**

Used to confirm the line status or seize a line.

**8 Receiver**

**9 Display**

For details, see "Display", Page 29.

**10 Soft Keys**

A/B/C (located from left to right) are used to select the item displayed on the bottom line of the display. For details about the soft keys displayed here, see "Soft Keys", Page 31.

## Before Operating the Telephones

---

**11**  **(POWER/CANCEL) Key**

Used to end calls, exit the phonebook or Function mode. Press and hold this key to turn the handset on or off.

**12**  **[XFER/CLR] Key**

Used to transfer a call to another party, or to clear digits or characters.

**13**  **[FUNC] Key**

Pressing this key followed by a keypad number (0–9) allows you to perform various common functions quickly. For details, see “Function Keys”, Page 40.

**14** **Microphone**

**15** **Charge Contacts**

**16** **Strap Holes**

Used to attach phone straps and similar items.

**17** **Speaker**

Desk Phone

KX-TPA65

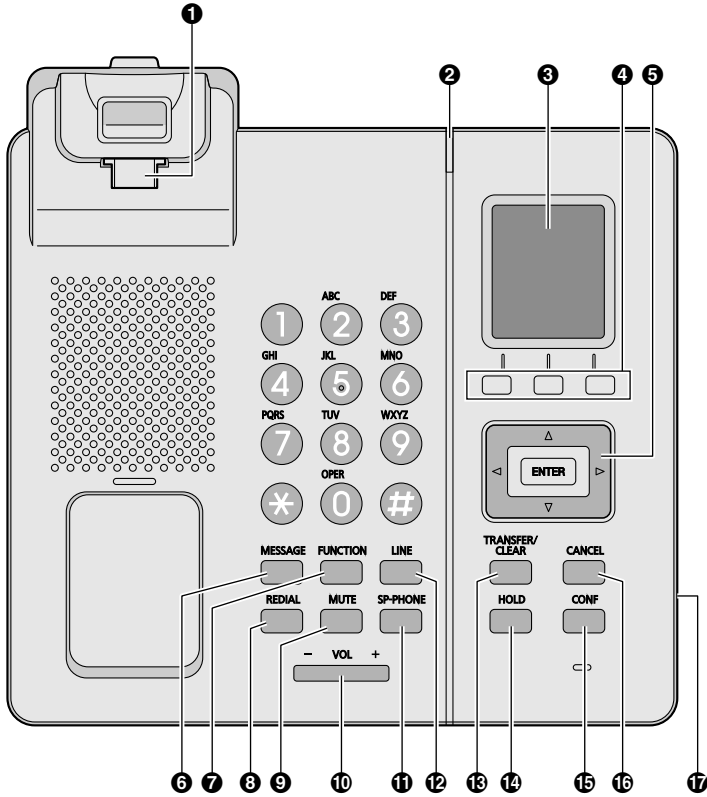

# Before Operating the Telephones

KX-TPA65AL, KX-TPA65LA, KX-TPA65LC, KX-TPA65UK, KX-TPA65X

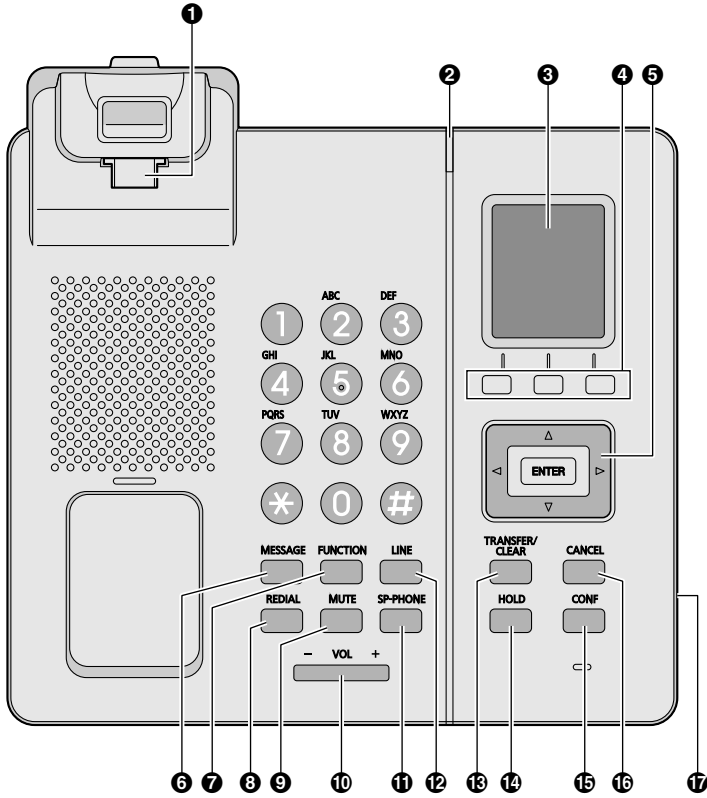



KX-TPA65C

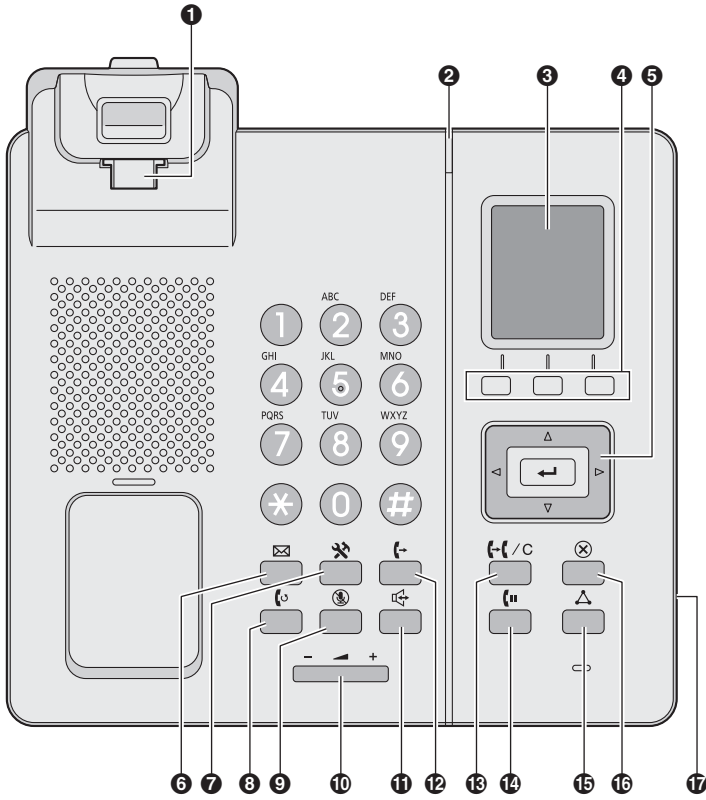

# Before Operating the Telephones

KX-TPA65CE

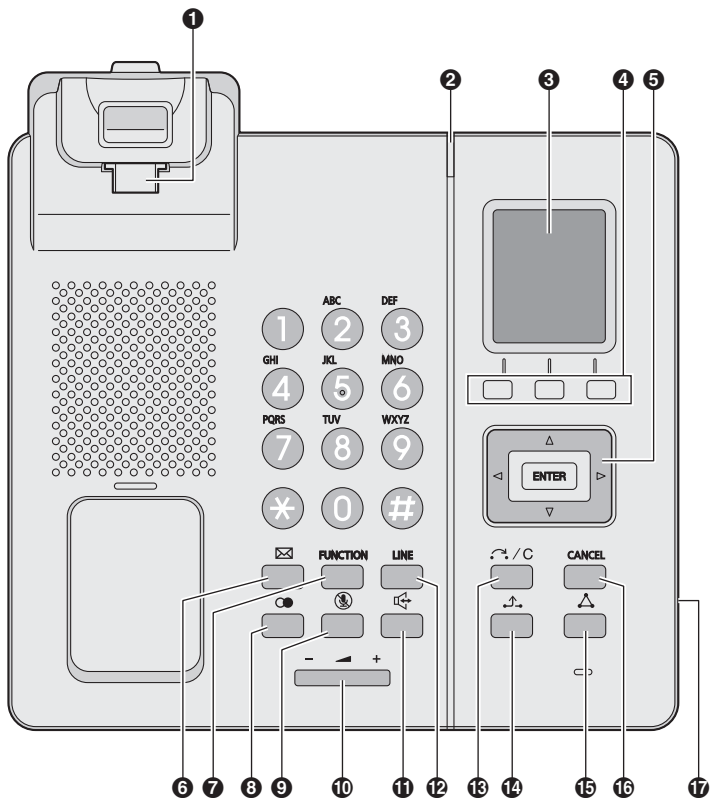

KX-TPA65RU

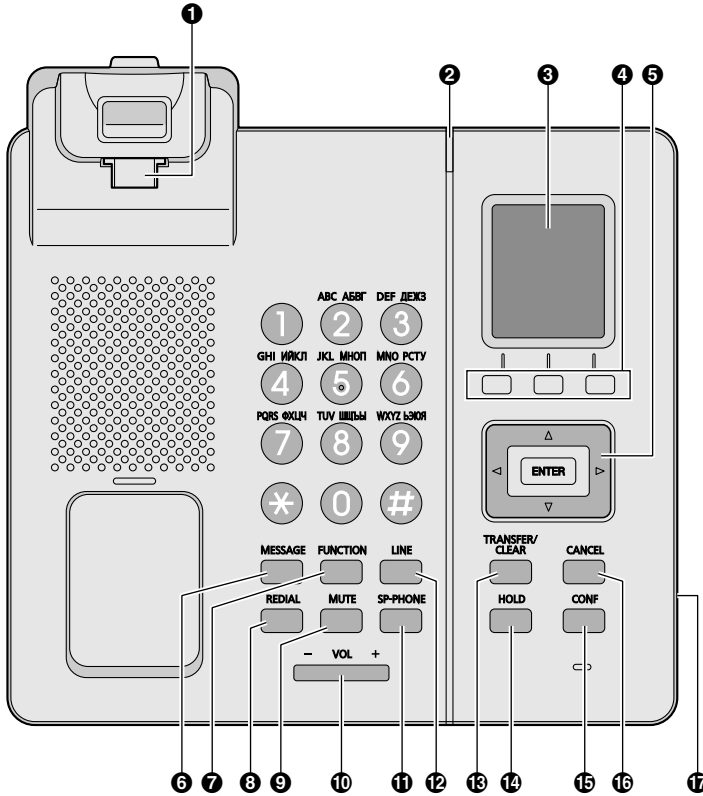

**1 Handset Hook**

Keeps the handset stable when the unit is mounted on a wall. For details, see “Hooking the Handset (KX-TPA65)”, Page 84.

**2 Ringer/Message Indicator**

If an incoming call arrives, the indicator blinks in accordance with the LED pattern setting.

Status		Meanings
Color	Light pattern	
Blue	Slow Flashing	There is a new missed call or voice mail.
	Quick Flashing	Receiving a call
Off	—	Power off

**3 Display**

**4 Soft Keys (A/B/C)**

A/B/C (located from left to right) are used to select the item displayed on the bottom line of the display. For details about the soft keys displayed here, see “Soft Keys”, Page 31.

## Before Operating the Telephones

---

### 5 Navigator Key

The Navigator Key includes four arrow keys and an enter key. The arrow keys are used to adjust the ringer/receiver volume or move the cursor to select an item. The enter key is used to confirm a selection. If in standby mode, pressing the keys perform the following functions:

LEFT (←) → Used to display the Incoming call log.\*1

UP (▲) → Used to adjust the ringer volume.

RIGHT (→) → Used to open the phonebook.\*1

DOWN (▼) → Used to display the Outgoing call log.

ENTER → Used to display the Menu.

\*1 When the BroadCloud (Presence) feature is enabled, the phone will operate as follows. Contact your administrator for further information.

LEFT: Used to display Presence.

RIGHT: Used to display Favorites.

In this manual, when a procedure instructs you to "press **OK**", you can also press the **[ENTER]** key to confirm the selection.

### 6 /[MESSAGE] Key

Used to access your voice mailbox.

### 7 /[FUNCTION] Key

Pressing this key followed by a keypad number (0–9) allows you to perform various common functions quickly. For details, see "Function Keys", Page 40.

### 8 /[REDIAL] Key

Used to redial the last dialed number.

### 9 /[MUTE] Key

Used to mute the microphone/handset during a conversation.

### 10 /[VOL] Key

Used to adjust the volume.

### 11 /[SP-PHONE] (Speakerphone) Key

Used for performing hands-free operations.

### 12 /[LINE] Key

Used to confirm the line status or seize a line.

### 13 / C / / C/[TRANSFER/CLEAR] Key

Used to transfer a call to another party, or to clear digits or characters.

### 14 /[HOLD] Key

During talking, used to place a call on Hold. In standby mode, used to retrieve a call on hold if there is one.

### 15 /[CONF] Key

Used to establish a multiple-party conversation.

### 16 /[CANCEL] Key

Used to cancel the selected item.

### 17 Headset Jack

The headsets can be used with this unit. (Not all operations with the headsets can be guaranteed.)

For up-to-date information about headsets that have been tested with this unit, refer to the following web site:

<http://www.panasonic.net/pcc/support/sipphone/>

## The Display and Icons

### Display

[Example]



#### 1 Pictograph







	Signal Strength Indicator - Strong		Battery Indicator*1 - Full
	Signal Strength Indicator - Medium		Battery Indicator*1 - Medium
	Signal Strength Indicator - Weak		Battery Indicator*1 - Low
	Signal Strength Indicator - Very weak		Battery Indicator*1 - Very low
	Signal Strength Indicator - Out of range		Battery Indicator*1 - Needs to be charged.
	Off-hook Status		Incoming Call Log
	Intercom Indicator*2		Outgoing Call Log
	Voice Message		Phonebook
	Navigator Key Guidance		

\*1 KX-TPA60 only.

\*2 Not displayed when connecting to a base unit other than the KX-TGP600.

## Before Operating the Telephones

### 2 Handset/Desk Phone Status Information

Suffix		Meaning
(none)/C/ LA/LC	UK/AL/ RU/CE	
		Ringer Off
		Silent Mode
		Auto Answer
		Base unit number (when registered to multiple base units)*1
		Registration number of handset/desk phone*1
<b>Fwd</b>		Call Forwarding
<b>DND</b>		Do Not Disturb*1

\*1 Not displayed when connecting to a base unit other than the KX-TGP600.

### 3 Time Display

### 4 Date, New Message or Missed Call Display

### 5 Handset/Desk phone number and Name (when connecting to a KX-TGP600 only)

### 6 Soft Keys

For more information, see Page 31.

#### Note







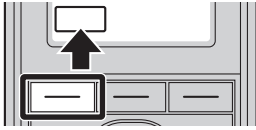

- Example images of the display in this manual are samples only, and the actual screen on your phone may vary in color and/or appearance.

## Soft Keys

Icons and information shown on the display will vary depending on the context. To select an item shown on the display, press the corresponding soft key.

### Soft Key A (Left key)



Suffix		Meaning
(none)/C/ LA/LC	UK/AL/ RU/CE	
		Returns to the previous display.
		Opens the phonebook. Pressing this key for more than 2 seconds locks the phonebook.
		Displayed when in Phonebook Lock. Pressing this key and then entering the password (default: not registered), unlocks the phonebook temporarily. Pressing for more than 2 seconds, then entering the password (default: not registered), unlocks the phonebook. If no password has been set, you cannot lock the phonebook. For details about setting the password, see “Setting the Password”, Page 43.
		Displays the caller information stored in the Handset Phonebook while receiving a call.
		Displays the caller information stored in the base unit while receiving a call.
<b>CONF</b>		Establishes a multiple-party conversation (Conference).
<b>MUTE</b>		Turns the microphone mute feature on or off during a conversation. Flashes when Mic Mute is on.
<b>ANSWER</b>		Answer Key

## Before Operating the Telephones

### Soft Key B (Middle key)

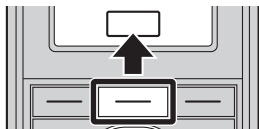





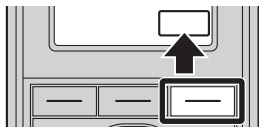





















Suffix		Meaning
(none)/C/ LA/LC	UK/AL/ RU/CE	
<b>OK</b>		Confirms the entry.
<b>MENU</b>		Opens the main menu. When in standby mode, pressing this key for more than 2 seconds locks all keys.
<b>MENU</b>		Opens the list menu (edit/delete in the phonebook, etc.).
		Stores a new item in the phonebook.
<b>CALL</b>		Makes a call.
		Displayed when in Key Lock mode. Pressing this key for more than 2 seconds unlocks the keys.
		Turns the ringer off.

### Soft Key C (Right key)



Suffix		Meaning
(none)/C/ LA/LC	UK/AL/ RU/CE	
<b>NEXT</b>		Advances to the next display.
		Displays the Outgoing Call Log.
		Opens the Incoming Call Log.
<b>REDIAL</b> *3		Displays the last dialed number.
<b>P</b> *3		Pause key
<b>BLIND</b> *1		Perform an unscreened (blind) transfer.
<b>ABC</b>		Displayed when in Latin character entry mode.
<b>0-9</b>		Displayed when in Numeric character entry mode.
<b>+AA</b>	<b>AA</b>	Displayed when in Special character (Extended 1) entry mode.



	Displayed when in Special character (Extended 2) entry mode.	
	Displayed when in Greek character entry mode.	
	Clears digits or characters.	
	Searches for an item in the phonebook alphabetically.	
	Used to select an item when in setting mode.	
	Used to select AM or PM when setting the Memo Alarm feature.	
 *4	 *4	Disconnects the current call and allows you to make another call without hanging up.
	Used to cancel the setting.	
		Used to delete the setting.
		Activate/deactivate Noise Reduction.*2
	Used to save a setting.	
	Displayed when in Cyrillic character entry mode.	
		Used to make or answer intercom calls.
		Reject an incoming call.
 *4	Used to set/clear the Auto Answer mode when in standby mode. During a conversation, turns the microphone mute feature on or off. For details about the Mute/Auto Answer function, see "Function Keys", Page 40.	
 *4	 *4	Used to set Call Forwarding and Do Not Disturb.
 *3*4	Used to retrieve a parked call (Call Parking).	
 *4	Dials the number assigned to the Hot Key.	
 *3*4	Used to make a Multicast Voice Paging call.	
 *4	Used to set a Memo Alarm.	

\*1 Not displayed when connecting to a base unit other than the KX-TGP600.

\*2 KX-TPA60 only.







\*3 This soft key is displayed only when configured on the telephone.

\*4 This soft key can be configured to appear as Soft Key A, B, or C.

### Editing Soft Keys

#### Changing the default settings

[In standby mode]

-  / 
- []/[]/[]/[]:  → 
- []/[]: "Key Option" → 



## Before Operating the Telephones

---

4. [▲]/[▼]: "Soft Key Edit" → **OK**
5. [▲]/[▼]: Select a desired soft key. → **OK**
6. [▲]/[▼]: "Standby"/"Talking" → **OK**
7. [▲]/[▼]: "Default" → **OK**



### Assigning Function Keys

[In standby mode]

1. /MENU
2. [▲]/[▼]/[◀]/[▶]:  → **OK**
3. [▲]/[▼]: "Key Option" → **OK**
4. [▲]/[▼]: "Soft Key Edit" → **OK**
5. [▲]/[▼]: Select a desired soft key. → **OK**
6. [▲]/[▼]: "Standby"/"Talking" → **OK**
7. [▲]/[▼]: "Function Key" → **OK**
8. [▲]/[▼]: Select the desired item. → **OK**

### Assigning Hot Key Dial keys

[In standby mode]

1. /MENU
2. [▲]/[▼]/[◀]/[▶]:  → **OK**
3. [▲]/[▼]: "Key Option" → **OK**
4. [▲]/[▼]: "Soft Key Edit" → **OK**
5. [▲]/[▼]: Select a desired soft key. → **OK**
6. [▲]/[▼]: "Standby"/"Talking" → **OK**
7. [▲]/[▼]: "Hot Key Dial" → **OK**
8. [▲]/[▼]: Select the desired item. → **OK**

## LINE Key

The LINE Key can be used either to seize a line in order to make or receive a call. In standby mode, press the LINE key to display a list of available lines. The color of each line number indicates the status of the line or the status of the function assigned to the key. The icon displayed on the next line shows the status of each line. Lines that are available can be changed using Multiline Setting. See "System Settings", Page 99.

However, when connecting to a base unit other than the KX-TGP600, you can only seize a line using this key. You cannot check the status of the lines.

### [Example]

- When connected to a KX-TGP600

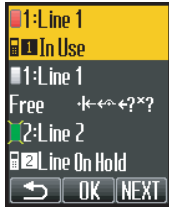

- To select a key, press [▲] or [▼] to select the desired key. → **OK**
- If you press a dial key when displaying the line status, only the limited line is displayed.
- The line name can be changed. Contact your administrator for further information.

### Status Indication\*1





Status		Meaning
Color	Light pattern	
Green	On	"In Use" ● You are on a call.
	Slow Flashing	"Line On Hold" ● A call is on hold.
	Quick Flashing	"Incoming Call/Recall" ● A call (including Hold Recall) is being received.
Red	On	"In Use" ● A shared line is in use or on private hold at another unit.
	Slow Flashing	"Line On Hold" ● A shared line is on hold at another unit.
	Quick Flashing	"Incoming Call" ● A call to a shared line is being received.
Off	—	"Free" ● The line is idle.

\*1 The meanings of these colors of key numbers vary depending on the status of the outside line.

### Status Icon

Icons	Description
	Shows the number (1–8) of the handset/desk phone which is in use or on hold.

## Before Operating the Telephones

Icons	Description
	Shows the Block Anonymous Call setting. For details about operation, see “Call Settings”, Page 100.
	Displayed when an Anonymous Call is specified. For details about operation, see “Call Settings”, Page 100.
	Displayed when Call Forwarding is specified.
	Displayed when Do Not Disturb (DND) is specified.
	Displayed when the Privacy setting is turned off.
<x>	Displays the index number of the shared line. (x: the index number)

## Operation Outline

### Screen Transition Diagram

Handset/Desktop Phone functions are accessed through the display menu and selected with the soft keys.

[Example]



\*1 The Line Status screen is different depending on whether connected to a KX-TGP600 or another base unit. For details, see "LINE Key", Page 35.

\*2 [FUNCTION] for the KX-TPA65.

\*3 The Function Keys screen is different depending on whether connected to a KX-TGP600 or another base unit. For details, see "Function Keys", Page 40.

- The selected item will be highlighted.
- To enter characters, see "Character Mode Table", Page 88.

- To search for an item in the Phonebook, see “Using the Phonebook”, Page 62.

## Function Menus

Press  /**MENU** or the [CENTER]/[ENTER] navigation key to display the main and sub menus.

### Main Menu—While in Standby Mode



**Incoming Log (Page 41)**  
Enters the Incoming Call Log.



**Ringer Volume (Page 40)**  
Accesses the "Ringer Volume" setting.



**New Phonebook (Page 63)**  
Stores a new item in the Phonebook.



**Setting Handset (Page 74)**  
Accesses the "Setting Handset" setting.



**System Settings (Page 75)**  
Accesses the "System Settings" setting.



**Memo Alarm (Page 73)**  
Accesses the "Memo Alarm" setting.

### Sub Menu—While Off-hook/During a Conversation



**Phonebook (Page 66)**  
Opens the Phonebook.



**New Phonebook (Page 63)**  
Stores a new item in the Phonebook.



**Outgoing Log (Page 41)**  
Enters the Outgoing Call Log.



**Incoming Log (Page 41)**  
Enters the Incoming Call Log.



**Mute (Page 59)**  
Turns the microphone mute feature on or off during a conversation.



**Noise Reduction (Page 54) (KX-TPA60 only)**  
Turn the noise reduction feature on or off.

## Before Operating the Telephones

---

### Function Keys

Handset/desk phone functions can be activated through the display key list.

In standby mode or during a conversation, press /[FUNC]/[FUNCTION] to display the function key list.

The followings are by default, and you can change the key list. The list order may differ depending on your country/area. For details, see Page 74.

**1: Redial (Page 48)**

Redials the last dialed number.

**2: Fwd/DND\*1 (Page 61)**

Displays and/or sets Call Forwarding and Do Not Disturb.

**3: Conference (Page 58)**

Establishes a multiple-party conversation.

**4: Auto Answer**

Answers an incoming call automatically in Hands-free mode.

**5: Flash/Recall (Page 47)**

Disconnects the current call and allows you to make another call without hanging up.

**6: Incoming Log (Page 41)**

Makes a call using the Incoming Call Log.

**7: Outgoing Log (Page 41)**

Makes a call using the Outgoing Call Log.

**8: Phonebook (Page 62)**

Makes a call using the Phonebook.

**9: Call Park\*2 (Page 57)**

Used to park or retrieve a call in a preset parking zone.

**0: Paging\*2 (Page 51)**

Makes a voice announcement to the handsets or the desk phones simultaneously.

\*1 "Call Forward" when connected to a base unit other than the KX-TGP600.

\*2 "Call Park" and "Paging" are displayed only when they are enabled in settings. Contact your administrator for further information.

---

## Adjusting the Volume

### Adjusting the Receiver/Speaker/Headset Volume

During a conversation, press [▲] or [▼] to adjust the volume (Level 1–6).



#### Note

- When using a KX-TPA65, the volume can also be adjusted by using /[VOL].

---

### Adjusting the Ringer Volume or Turning the Ringer Off

[In standby mode]

1. /MENU
2. [▲]/[▼]/[◀]/[▶]:  → **OK**
3. [▲]/[▼]: Select the desired setting. → **OK** \*1



\*1 When using a KX-TPA65, the volume can also be adjusted by using /[VOL].

### Note

- You can press the key instead of performing steps 1 and 2.
- For details about setting the ringer pattern, see "Incoming Option", Page 91.

### Adjusting the Ringer Volume or Turning the Ringer Off while Ringing

While receiving a call, do the following to adjust the ringer volume or turn the ringer off:

### Note

- If you attach a headset while receiving an incoming call, the ring from the handset does not switch to the headset. If you attach a headset before receiving an incoming call, and headset ringer is set to "On", ringing will be heard from the headset.

### To adjust the ringer volume

1. /[]: Adjust the volume.\*1
2. KX-TPA60:

/ / /[XFER/CLR]: Exit

KX-TPA65:

/[CANCEL], /C//[TRANSFER/CLEAR]: Exit

- \*1 The adjusted volume level will also be used for subsequent calls.

When using a KX-TPA65, the volume can also be adjusted by using /[VOL].

### To turn the ringer off

- 1.

---

## Incoming/Outgoing Call Log

When connecting the desk phone and handset in parallel, the Incoming/Outgoing Call Log is shared between the desk phone and handset. For details about parallel connection settings, see "Parallel Mode (KX-TPA65 only)", Page 42.

---

### Displaying the Incoming Call Log

[In standby mode]

- 1.
2. /[]: "Incoming Log" →

- \*1 If "Missed Calls" is not displayed on the LCD in standby mode, this step can be skipped.

When connected to a base unit other than the KX-TGP600, since "Incoming Log" is not displayed, select from "Missed Call"/"Answered Call".

### Note

- For details about the other operations, see "Screen Transition Diagram", Page 37.

---

### Displaying the Outgoing Call Log

[In standby mode]

- 1.

\*1 You can also press / .

### Note

- For details about the other operations, see "Screen Transition Diagram", Page 37.

## Before Operating the Telephones

---

### Making a call using the Incoming/Outgoing Call Log

See "Using the Incoming/Outgoing Call Log", Page 49.

---

### Storing an item using the Incoming/Outgoing Call Log

See "Storing an Item Using the Incoming or Outgoing Call Log", Page 64.

---

### Deleting the Incoming Call Log

#### [When the Incoming Call Log is displayed]

1. [▲]/[▼]: Select the desired item. → /MENU
  2. [▲]/[▼]: "Delete"\*1 → **OK**
  3. [▲]/[▼]: "Yes" → **OK**  
To delete other items, go back to Step 1.
- \*1 You can select "Delete All" instead to delete all items.
- 

### Deleting the Outgoing Call Log



#### [When the Outgoing Call Log is displayed]

1. [▲]/[▼]: Select the desired item. → /MENU
  2. [▲]/[▼]: "Delete"\*1 → **OK**
  3. [▲]/[▼]: "Yes" → **OK**  
To delete other items, go back to Step 1.
- \*1 You can select "Delete All" instead to delete all items.
- 

## Parallel Mode (KX-TPA65 only)

By using a desk phone as a master desk phone (KX-TPA65), a handset (KX-TPA60) can be set to be paired with it so that the phone number (account) of the master desk phone is applied to the slave (paired) handset. With pairing settings, the desk phone can be used while you are sitting at your desk, and the slave handset can be used while away from your desk.

KX-TPA65:

1. /MENU
2. [▲]/[▼]/[◀]/[▶]:  → **OK**
3. [▲]/[▼]: "System Settings" → **OK**
4. [▲]/[▼]: "Parallel Setting" → **OK**
5. [▲]/[▼]: Select the desk phone (KX-TPA65) to use as the master unit. → **OK**
6. [▲]/[▼]: "Pairing" → **OK**
7. [▲]/[▼]: Select the handset (KX-TPA60) to use as the paired unit.
  - To cancel pairing: "Off" → **OK**
8. [▲]/[▼]: "Mode" → **OK**
9. [To make one unit receive a busy signal while the other is on a call]  
[▲]/[▼]: "Busy" → **OK**  
[To make one unit take over a call when the other is on a call]  
[▲]/[▼]: "Take Over Call" → **OK**

For details about the setting, see Parallel Setting (KX-TPA65 only) Page 100.

---

---

## Setting the Password

The handset/desk phone password is not set by default. You must register a handset/desk phone password (4 digits) before use. You cannot use the following features without setting a password:

- Phonebook lock (See "Locking the Handset Phonebook", Page 68).
- "Manual&Password" or "Auto&Password" for "Key Lock Type" (See "Key Option", Page 93).
- Reset Handset (See "Other Option", Page 97).



### Note

- To avoid unauthorized access to this product:
  - Set a password that is random and cannot be easily guessed.
  - Change the password regularly.
- Make a note of the password so that you will not forget it.

---

### To set

[In standby mode]

1.  / **MENU**
2. [**▲**]/[**▼**]/[**◀**]/[**▶**]:  → **OK**
3. [**▲**]/[**▼**]: "Other Option" → **OK**
4. [**▲**]/[**▼**]: "Change Password" → **OK**
5. Enter a new password (4 digits [0–9]).
6. Verify the password by entering it again as in step 5.

---

## Key Lock



You can lock all keys other than the Navigator Key while the handset/desk phone is in standby mode. One of 4 key lock types can be selected. For details, see "Key Option", Page 93.

### Note

- If you select "Manual&Password" or "Auto&Password" for "Key Lock Type", you need to enter the password to unlock the handset/desk phone.  
If you enter an incorrect password 3 times, you cannot enter another password for approximately 30 seconds.
- If no password has been set, you cannot select "Manual&Password" or "Auto&Password" for "Key Lock Type". To set the password, see "Setting the Password", Page 43.
- When "Auto" or "Auto&Password" is selected, the inactive time until keys are automatically locked (Auto Lock Time) can be set. See "Key Option", Page 93.



---

### To lock

Press and hold  / **MENU** or the [CENTER]/[ENTER] Navigator Key for more than 2 seconds to lock the handset/desk phone keys. The  icon will be displayed to indicate that the keys are locked.

---

### To unlock

To unlock the handset/desk phone keys, press and hold  or the [CENTER]/[ENTER] Navigator Key for more than 2 seconds. The  icon will change to  / **MENU** to indicate the keys have been unlocked.

## Selecting the Display Language

You can select the language displayed on your handset/desk phone.

[In standby mode]

1. /MENU
2. [▲]/[▼]/[◀]/[▶]: → **OK**
3. [▲]/[▼]: "Display Option" → **OK**
4. [▲]/[▼]: "Language" → **OK**
5. [▲]/[▼]: Select a language. → **OK**

- The handset/desk phone will restart after changing the Display Language.
- For a list of the languages that can be selected, see "Display Option", Page 95.

## Entering Characters

You can enter characters and digits using the dialing keys.

You can select one of the character modes by pressing the **Right Soft Key** while entering a name. The function icon above the soft key displays the current character mode.

For available characters, see "Character Mode Table", Page 88.

To change the character mode while editing a name in the Phonebook, press the **Right Soft Key**.

Model No.	Character Mode Transition
KX-TPA60, KX-TPA60C KX-TPA65, KX-TPA65C	(Latin) ↓ (Numeric) ↓ (Extended 1) ←
KX-TPA60CE, KX-TPA60UK, KX-TPA60AL, KX-TPA60LA, KX-TPA60LC KX-TPA65CE, KX-TPA65UK, KX-TPA65AL, KX-TPA65LA, KX-TPA65LC, KX-TPA65X	(Latin) ↓ (Numeric) ↓ (Greek) ↓ (Extended 1) ↓ (Extended 2) ←
KX-TPA60RU KX-TPA65RU	(Cyrillic) ↓ (Numeric) ↓ (Latin) ↓ (Extended 1) ↓ (Extended 2) ←

**Example: To enter "Anne" in Latin Mode.**

2 → [▶] → [\*] → 6 → 6 → [▶] → 6 → 6 → [▶] → 3 → 3

- To switch between uppercase and lowercase, press

KX-TPA60:



KX-TPA65:



- To enter a character located on the same dialing key as the previous character, move the cursor by pressing the Navigator Key [▶], then enter the desired character.
- To edit an entered character
  1. Press [◀] or [▶] to highlight the character.
  2. Delete the character.

KX-TPA60:



KX-TPA65:

↶ / c / [▶] / c / [TRANSFER/CLEAR]

3. Enter the correct character.

- To clear an entire line.

KX-TPA60:



KX-TPA65:

Press and hold ↶ / c / [▶] / c / [TRANSFER/CLEAR] for more than 1 second.

- To move the cursor, press the Navigator Key [◀], [▶], [▲] or [▼].

## Power On/Off (KX-TPA60 only)

To turn the power of the handset on or off, press and hold .

## Power Save Mode



Power Save Mode turns off the ringer, LCD backlight, and/or key backlight automatically after a set number of seconds have passed while receiving a call. For details about adjusting power save mode settings, see "Incoming Option", Page 91.

## Basic Operation

Basic operations for the KX-TPA65 are described here.

### Going off- and on-hook

There are several ways to go off-hook and on-hook:





- Using the corded handset
- Using the /[SP-PHONE], /[CANCEL] key
- Using the soft key

## ***Before Operating the Telephones***

---

### **Going off-hook**

In this manual, when you see the phrase "off-hook", you can do any of the following:



- Lift the corded handset off its cradle.
- Press /[SP-PHONE] while the corded handset is on its cradle. This enables hands-free mode.
- Press /[SP-PHONE] when using a headset.
- Press /[LINE], and then press a dial key or /[] to select the line number.

### **Note**











- Certain soft keys, such as **ANSWER**, function like the /[SP-PHONE] key.
- 

### **Going on-hook**

In this manual, when you see the phrase "on-hook", you can do any of the following:



- Replace the corded handset on its cradle.
- Press /[SP-PHONE] when using a headset or when you are in hands-free mode.
- Press /[CANCEL].

## Making Calls

- To enter characters, see “Entering Characters”, Page 44
  - You can confirm that the number was dialed correctly before calling (Predialing) by entering the number, then  
KX-TPA60:  
Press .  
KX-TPA65:  
Off-hook
  - To clear an entire number while predialing,  
KX-TPA60:  
Press  /  [XFER/CLR] for more than 1 second.  
KX-TPA65:  
Press  /  /  [TRANSFER/CLEAR] for more than 1 second.
  - If an outside call is received from a phone number stored in the Handset Phonebook, the number and name of the caller will be displayed in the call log.
  - To cancel dialing, press  
KX-TPA60:  
  
KX-TPA65:  
 [CANCEL]
  - If  flashes, move closer to the base unit and dial again.
  - To insert a 3 second pause between phone numbers, press \*1.  
It is useful when you want to operate voice mail service without listening to pre-recorded announcement, for example. Repeat as needed to create longer pauses.
- \*1 This soft key is displayed only when configured on the telephone. Contact your administrator for further information.

## Basic Calling

### Calling by Dialing

1. KX-TPA60:  
  
KX-TPA65:  
Off-hook
2. Dial the outside party's number.
3. **CALL**
4. KX-TPA60:  
; End the call  
KX-TPA65:  
On-hook: End the call

#### Note

To dial a new number without going on-hook, follow the procedure below.

1.  [FUNC]/[FUNCTION]: End the call

## Making Calls

---

2. [▲]/[▼]: "Flash/Recall"

3. **OK**

### Predialing

#### [In standby mode]

1. Dial the number while on-hook.

2. After dialing

KX-TPA60:



KX-TPA65:

Off-hook

---

## Making an Intercom Call

Intercom calls can be made between handsets/desk phones.

#### [In standby mode]

1.  / **MENU**

2.  / **INT**

3. [▲]/[▼]: Select a desired handset/desk phone. → **OK**

4. KX-TPA60:



End the call

KX-TPA65:

On-hook: End the call

---

## Easy Dialing

### Making a Call Using the Redial List

The last phone number dialed is stored in the redial list (each 32 digits max.).

#### [In standby mode]

1. /[FUNC]/[FUNCTION] → **1**

#### Note

- If the Redial key is not assigned to dial key **1**, press the actual assigned dial key.
- When using a KX-TPA65, /[REDIAL] can also be used.

---

### Hot Key Dialing

You can assign a phone number to each number key and then access the desired phone number by simply pressing and holding the assigned number key.

1. Press and hold the dialing key (0–9) assigned as a Hot Key for more than 1 second.

2. KX-TPA60:



KX-TPA65:

Off-hook



## Note

- While the Hot Key's information is displayed, you can press [▲] or [▼] to select another Hot Key number.
- If Hot Key dialing is set to "Auto", a Hot Key number can also be dialed by pressing and holding the assigned dialing key for a specified number of seconds. For details, see "Selecting the Type of Hot Key Dialing", Page 73.
- For details about assigning Hot Keys, see "Assigning Hot Keys From Phonebook", Page 72.

---

## Using the Hot Line

If your administrator has configured this function, you can make a call to a registered phone number automatically. Contact your administrator for further information.

### [In standby mode]

1. KX-TPA60:



KX-TPA65:

Off-hook

---

## Using the Incoming/Outgoing Call Log

### Using the Incoming Call Log

#### [When the Incoming Call Log is displayed]

1. [▲]/[▼]: Select an incoming call log.

2. Make a call

KX-TPA60:



KX-TPA65:

Off-hook

3. End the call

KX-TPA60:



KX-TPA65:

On-hook

---

### Using the Outgoing Call Log

#### [When the Outgoing Call Log is displayed]

1. [▲]/[▼]: Select an outgoing call log.

2. Make a call

KX-TPA60:



KX-TPA65:

Off-hook

3. End the call

KX-TPA60:







KX-TPA65:

On-hook

## Using the Phonebook

### Using the Handset Phonebook

[In standby mode]

1. 
2. [▲]/[▼]: "Phonebook" → **OK**\*1
3. Enter the name or the first character(s) of the desired name. → **OK**
4. [▲]/[▼]: Select the desired item. → /MENU\*2
5. [▲]/[▼]: Select the desired phone number.
6. KX-TPA60:  
  
KX-TPA65:  
Off-hook
7. KX-TPA60:  
: End the call  
KX-TPA65:  
On-hook: End the call

\*1 If only Handset Phonebook is permitted, this step is skipped.





\*2 If you push and hold [▲]/[▼], the next/previous items will be displayed automatically.

### Note

- If the Handset Phonebook is not permitted, this feature cannot be used. For details, contact your phone system dealer/service provider.
- For details about making a call using the Handset Phonebook, see "Searching for an Item in the Handset Phonebook", Page 66.

### Using the Base unit Phonebook (when connected to a base unit other than the KX-TGP600 only)

[In standby mode]

1. 
2. [▲]/[▼]: "Base Phonebook" → **OK**
3. Enter the name or the first character(s) of the desired name. → **OK**
4. [▲]/[▼]: Select the desired item. → /MENU\*1
5. [▲]/[▼]: Select the desired phone number.
6. KX-TPA60:  
  
KX-TPA65:  
Off-hook
7. KX-TPA60:  
: End the call  
KX-TPA65:  
On-hook: End the call



\*1 If you push and hold [▲]/[▼], the next/previous items will be displayed automatically.

### Note

- For details about making a call using the Base unit Phonebook, see "Searching for an Item in the Base Unit Phonebook", Page 70.

**Using the Remote Phonebook (when connected to a base unit other than the KX-TGP600 only)**

[In standby mode]

1.  1
2. [▲]/[▼]: "Remote Phonebook" → **OK**\*1
3. Enter the name or the first character(s) of the desired name. → **OK**
4. [▲]/[▼]: Select the desired item. → /MENU\*2
5. Press [▲] or [▼] to select the desired phone number.
6. KX-TPA60:



KX-TPA65:  
Off-hook

7. KX-TPA60:  
: End the call

KX-TPA65:  
On-hook: End the call

- \*1 If only Remote Phonebook is permitted, this step is skipped.
- \*2 If you push and hold [▲]/[▼], the next/previous items will be displayed automatically.

**Note**

- If the Remote Phonebook is not permitted, this feature cannot be used. For details, contact your phone system dealer/service provider.
- For details about making a call using the Remote Phonebook, see "Searching for an Item in the Remote Phonebook", Page 71.

## Making a Multicast Voice Paging Call

When you make a paging call from the handset/desk phone, the voice will be heard through the speaker phone of the other handsets/desk phones.

[In standby mode]

1. /[FUNC]/[FUNCTION]
2. [▲]/[▼]: "Paging" → **OK**
3. [▲]/[▼]: Select a desired channel group. → **OK**

**Note**

- This feature can be enabled through Web user interface programming. For details, contact your phone system dealer/service provider.

### Receiving Calls

- You can select the ringer for each type of incoming call. See “Incoming Option”, Page 91.
- You can also use "Any Key Answer"\*1, "Quick Answer"\*1 or "Auto Answer" to answer a call. See “Answer Option”, Page 92.
- The volume of the ringer can be adjusted, or turned off. See “Adjusting the Ringer Volume or Turning the Ringer Off”, Page 40.
- If you attach a headset before receiving an incoming call, and headset ringer is set to "On", ringing will be heard from the headset.
- Please consider the following when "Quick Answer"\*1 is set to "On". If a brief power failure occurs when the handset is receiving a call on the charger,
  - if "Talk On Charger" is set to "Off" (default), the call may be disconnected after being answered.
  - if "Talk On Charger" is set to "On", the call may be answered automatically. In this case, please note that privacy rights may be violated or sensitive information may be transmitted to unauthorized parties.

\*1 KX-TPA60 only.

---

### Caller ID

If an outside call that contains Caller ID information (a caller's name and telephone number) is received, this information will be logged in the incoming call log and displayed on the handset/desk phone.

If a call from a number matching a number entered in the phonebook is received, the name registered in the phonebook for that number will be displayed along with the number.

If caller information is sent by the phone system and there is also information stored in the phonebook for the same number, you can choose which information will be displayed on the handset/desk phone. Caller information sent by the phone system is displayed by default. For details, see “Display Option”, Page 95.

If you set the handset/desk phone to display the caller information stored in the phonebook, caller information sent by the phone system will only be displayed if the number of the caller is not stored in the phonebook.

---

### Answering Calls

#### To answer an incoming call

- KX-TPA60: 
- KX-TPA65: Off-hook

#### Note

- When receiving an intercom call, the Handset Name is displayed on the LCD.

---

#### To answer an incoming call on a specific line (when connected to the KX-TGP600 only)

1. **[↔]/[LINE]**: Display the line keys.
2. Press the dial key or **[▲]/[▼]** to select the Line number. → **OK**  
You can also answer a call using the following features:
  - Any Key Answer\*1
  - Quick Answer\*1
  - Auto Answer

For details about setting these features, see “Answer Option”, Page 92.

\*1 KX-TPA60 only.

**Note**

- Line keys with incoming calls will be flashing green rapidly.
- If "Quick Answer"<sup>\*1</sup> is set to "On" and a brief power failure occurs while the handset is receiving a call on the charger, the following may occur:
  - If "Talk On Charger" is set to "Off" (default), the call may be disconnected after being answered.
  - If "Talk On Charger" is set to "On", the call may be answered automatically. In this case, please note that privacy rights may be violated or sensitive information may be transmitted to unauthorized parties.
- \*1 KX-TPA60 only.
- You can select the ringer pattern for each type of incoming call. For details, see "Incoming Option", Page 91.

**Rejecting an incoming call**

You can reject an incoming call from your handset/desk phone.

1. While an incoming call is ringing, press  /REJECT.
2. The call will be rejected, and the handset/desk phone will return to standby mode.

**Note**

- Calls from specific numbers can be automatically rejected. For details, see "Incoming Call Barring (Caller ID service users only)", Page 76.

## Hands-free Mode



In hands-free mode, you can talk and hear the other party in a conversation without using the handset. This mode is useful for performing other tasks during a conversation, such as writing.

**Note**

[KX-TPA60]

- During a conversation using the headset, the  key is not available.
- While a handset in hands-free mode is on its charger, you cannot cancel the mode.
- When "Talk On Charger" is set to "On", if you place the handset in hands-free mode on the charger, you can continue the conversation.

[KX-TPA65]

- During a conversation using the headset, pressing the /[SP-PHONE] key will disconnect the call.
- If you press /[SP-PHONE] during hands-free mode, you will disconnect the call.

**Enabling hands-free mode**

[KX-TPA60]

If you press  during a conversation, you can enable hands-free mode.

You can then return the handset to its charger.

[KX-TPA65]

If you press /[SP-PHONE] in standby mode, you can enable hands-free mode. Once in hands-free mode, you can go on-hook without disconnecting the call.

**Canceling hands-free mode**

[KX-TPA60]

You can cancel hands-free mode in one of the following ways:

- During a conversation in hands-free mode, press .

## Receiving Calls

---

- During a conversation in hands-free mode with the handset on the charger, lift the handset off its charger.

[KX-TPA65]

During a conversation in hands-free mode, go off-hook.

---

## Answering an Intercom Call

1. KX-TPA60:



: Answer the page.

KX-TPA65:

Off-hook: Answer the page.

---

## Silent Mode

Silent Mode turns off the ringer when calls are received. This can be useful in situations where you do not want to be disturbed, such as during a meeting.

When Silent Mode is active, the following features are turned off or set as specified automatically, regardless of their settings.

- Ringer Volume
- Ring On Charger\*<sup>1</sup>
- Auto Answer
- Key Tone

\*<sup>1</sup> KX-TPA60 only.

### Note

- When Silent Mode is set, the Low Battery Alarm will not be heard in standby mode.
  - When Silent Mode is set, confirmation tones for setting the ring pattern or ring volume will not play.
- 

### To set or cancel

1. KX-TPA60:

Press and hold  for more than 2 seconds.

KX-TPA65:

Press and hold  for more than 2 seconds.

---

## Noise Reduction/Voice Clarity (KX-TPA60 only)

When Noise Reduction is enabled, environmental noise is reduced to improve and maintain sound quality for the other party in the conversation. Receiver volume is also increased according to the level of environmental noise. It is useful in noisy environments such as warehouses, manufacturing plants, restaurants, and garages. Noise Reduction can be enabled by default for regular use, or toggled on/off during a call.

### Note



- Noise Reduction can be used only in receiver mode or with a headset. It cannot be used in Hands-free mode.
  - During a conversation in Noise Reduction mode, either the  / **AVC** soft key will blink, or "Noise Reduction" will be displayed on the LCD.
-

- During a conversation with a headset in default Noise Reduction mode, even if you disconnect the headset from the handset, Noise Reduction mode will continue.
- During a conversation without a headset in default Noise Reduction mode, even if you connect the headset to the handset, Noise Reduction mode will continue.

---

### Enabling or disabling Noise Reduction





[In standby mode]

1.  / **MENU**
2. [**▲**]/[**▼**]/[**◀**]/[**▶**]:  → **OK**
3. [**▲**]/[**▼**]: "Talk Option" → **OK**
4. [**▲**]/[**▼**]: "Noise Reduction/Voice Clarity" → **OK**
5. [**▲**]/[**▼**]: "On"/"Off" → **OK**

---

### Temporarily enabling or disabling Noise Reduction during a call

You can enable or disable Noise Reduction during a call by doing either of the following:

- a.  / **AVC**  
To display the  / **AVC** soft key, edit the displayed soft keys. See "Key Option", Page 93.
- b. /[**FUNC**]/[**FUNCTION**] → [**▲**]/[**▼**]: "Noise Reduction/Voice Clarity" → **OK**
- c.  / **MENU** → [**▲**]/[**▼**]/[**◀**]/[**▶**]: "Noise Reduction/Voice Clarity" → **OK**

# During a Conversation

---

## Transferring a Call (Call Transfer)

You can transfer a call to another destination (extension or outside party).

---

### To transfer

#### [During a conversation]

1. KX-TPA60:



KX-TPA65:

↶ / C / ↷ / C / [TRANSFER/CLEAR]

2. Dial the party you want to transfer to. → **CALL**

3. Wait until the other party answers to announce the transfer.

4. KX-TPA60:



KX-TPA65:

On-hook\*1

\*1 When connected to a base unit other than the KX-TGP600, the operation is as follows.

KX-TPA60:



KX-TPA65:

↶ / C / ↷ / C / [TRANSFER/CLEAR]

### Note

- To return to the call before the transfer destination answers, press **CANCEL**.
- 

### To do a blind transfer (when connected to the KX-TGP600 only)

1. Press **BLIND**\*1 during a conversation.

2. Dial the party you want to transfer to. → **CALL**

\*1 If blind transfers are not permitted, this soft key is not displayed. Contact your administrator for further information.

---

### To transfer an intercom call

Outside calls can be transferred between 2 handsets/desk phones.

#### [In standby mode]

1.  / **MENU** during a conversation.

2.  / **INT**

3. [▲]/[▼]: Select a desired handset/desk phone. → **OK**

4. Wait for the paged party to answer.

5. KX-TPA60:



KX-TPA65:

On-hook\*1

\*1 When connected to a base unit other than the KX-TGP600, the operation is as follows.

---



KX-TPA60:



[XFER/CLR]

KX-TPA65:



[TRANSFER/CLEAR]

## Holding a Call

You can put a call on hold by holding the call at your extension.

### Holding

#### To hold the current call

1. KX-TPA60:



[HOLD/MSG]

KX-TPA65:



[HOLD]

### Note

- If you select a LINE key other than the one for the current call, the call is put on hold or is disconnected depending on the Automatic Call Hold settings. For details, contact your phone system dealer/service provider.

#### To retrieve a call on hold

1. KX-TPA60:



[HOLD/MSG]

KX-TPA65:



[HOLD]

#### To retrieve a call on hold at your line (when connected to the KX-TGP600 only)

1. [↔]/[LINE]

2. Press the dial key corresponding to the slowly flashing green LINE indicator, or press [▲] or [▼] to select a slowly flashing green LINE indicator. → **OK**

## Holding in a System Parking Zone (Call Park)

You can use this feature as a transferring feature.

When Call Park is permitted, the "Call Park" item is available in the Function Key list. However, the Call Park feature number must be set beforehand. Also, depending on your phone system, you may need to enter a parking zone number to retrieve a parked call. The feature depends on your phone system. Contact your administrator for further information.

### To set

1. [X]/[FUNC]/[FUNCTION] → [9] ("Call Park")

### To retrieve (Call Park Retrieve)

#### [In standby mode]

1. Enter the Call Park Retrieve feature number.

2. KX-TPA60: 

KX-TPA65: Off-hook

### Note

- Depending on the telephone system, the **PARK** soft key might blink to show that the line has a parked call. In this case, you can retrieve the call by pressing the blinking **PARK** soft key. However, to retrieve

## During a Conversation

---

a parked call using the soft key, the Call Park Retrieve feature number must be set beforehand. Contact your administrator for further information.

---

### Talking to Two Parties Alternately (Call Splitting)

When talking to one party while the other party is on hold, you can swap the calls back and forth (alternately).

#### To call a third party and then alternate between the two

1. KX-TPA60:

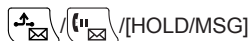

KX-TPA65:



2. Dial the other party's extension number.
3. After talking to the other party, press

KX-TPA60:

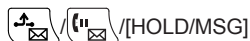

KX-TPA65:



4. Talk to the original party.
- 

## Three-party Conference

During a conversation, you can add an additional party to your call and establish a conference call.

### Note

- Your phone system may support advanced conference features, such as conference calls with four or more parties. In this case, the procedures for handling a conference call may be different from those explained in this section. For details, contact your phone system dealer/service provider.
- 

### Making a Conference Call

1. /[FUNC]/[FUNCTION] during a conversation. → "Conference"
2. Dial the party you want to add to the conversation. → **CALL**
3. **CONF** / (three people icon)

### Note

- The **CONF** / (three people icon) soft key can also be used to access the Conference function directly. To display this key, edit the displayed soft keys. For details, see "Key Option", Page 93.
  - When using a KX-TPA65, (triangle icon)/[CONF] can also be used at steps 1 and 3.
- 

### Removing a Party from the Conference (when connected to the KX-TGP600 only)

During a conference, you can remove other parties from the conference. However, this operation is available only during conference calls you initiate.

1. During a conference call, press

KX-TPA60:

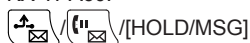

KX-TPA65:



2. /[LINE]
-

3. Press the dial key, or press [▲] or [▼], and then press **OK** to select the LINE number that corresponds to the party you want to disconnect.
4. KX-TPA60:  
 → **[\*]/[LINE]**  
KX-TPA65:  
On-hook → **[\*]/[LINE]**
5. Press the dial key, or press [▲] or [▼], and then press **OK** to select the LINE number that corresponds to the remaining party.

### Note

- To reestablish the conference without removing either party, press **[\*]/[FUNC]/[FUNCTION]**, and then "Conference" after step 3.

---

### Ending a Conference Call

To go on-hook and end the conference call,

KX-TPA60:

press .

KX-TPA65:

On-hook

---



### Mute

You can disable the microphone or the handset to consult privately with others in the room while listening to the other party on the phone through the speaker or the handset.

#### To set/cancel

1.  **/MUTE**

### Note

- When  **/MUTE** is blinking, Mute is on.  
If the  **/MUTE** soft key is not displayed on the LCD,  **/MUTE** is displayed on the 1st line of the LCD.
- During Mute, even if you switch from/to speakerphone, Mute will continue.
- During Mute, even if you connect/disconnect a headset, Mute will continue.
- When using a KX-TPA65, **[\*]/[MUTE]** can also be used.

---

### Call Waiting

During a conversation, if a second call arrives, you will hear a call waiting tone. You can answer the second call by disconnecting or holding the current call.

This is an optional telephone company service. You can receive a call waiting tone and the caller's information. For details, contact your phone system dealer/service provider.

---

### To disconnect the current call and then talk to the new party

#### [While hearing the call waiting tone]

1. KX-TPA60:



KX-TPA65:

On-hook

## During a Conversation

---

2. KX-TPA60:



KX-TPA65:

Off-hook

---

### To hold the current call and then talk to the new party

1.  / ANSWER

#### Note

- You can also answer call waiting as follows:

KX-TPA60:



[HOLD/MSG]

KX-TPA65:



[HOLD]

---

### Off-hook Monitor (KX-TPA65 only)

During a two-party conversation with the corded handset, you can allow other people to listen to the conversation through the speaker while you continue the conversation using the corded handset.

---

#### To start/To cancel

1.  / [SP-PHONE]

#### Note

- When off-hook monitor is active, replacing the corded handset to its cradle enables hands-free mode.

## Call Forwarding/Do Not Disturb

You can have incoming calls automatically forwarded to another destination. You can also have incoming calls rejected (Do Not Disturb).

### Note

- Do Not Disturb is available only when connected to a KX-TGP600.



### To access the FWD/DND settings

1. In standby mode, press /[FUNC]/[FUNCTION], and then **2** ("Fwd/DND"\*1).
2. If the unit has multiple lines, press **[▲]** or **[▼]** to select the desired line. → **OK**
3. **[▲]/[▼]**: Select the type of FWD or DND setting to apply. → **OK**  
The settings are as follows:
  - DND: Enable Do Not Disturb\*2  
(All incoming calls are automatically rejected.)
  - Fwd(All): Enable Forward All Calls  
(All incoming calls are forwarded.)
  - Fwd(Busy): Enable Forward Busy  
(Incoming calls are forwarded only when your extension is in use.)
  - Fwd(NA): Enable Forward No answer  
(An incoming call is forwarded if you do not answer the call within a certain amount of time.)
4. If a Forward setting is selected, enter a new forward destination number, or confirm and modify a previously set forward destination number. → **OK**

\*1 "Call Forward" when connected to a base unit other than the KX-TGP600.

\*2 Only when connected to a KX-TGP600.



### Note

- When Call Forwarding and/or Do Not Disturb is enabled, /Fwd and/or /DND appears on the display in standby mode.
- FWD settings cannot be used on a shared line.

## Listening to Voice Mail Messages (when connected to the KX-TGP600 only)

When you receive a voice message, "Voice MSG" is displayed, and  will appear. You can check your new messages by accessing your mailbox.

### [In standby mode]

1. Press and hold  
KX-TPA60:  
/[HOLD/MSG]  
KX-TPA65:  
/[MESSAGE]
2. **[▲]/[▼]**: Select the line on which  is displayed. → **OK**

### Note

- Step 2 is not necessary if only one line is configured on the handset/desk phone.
- When using a KX-TPA60, this feature cannot be used when you have a call on hold.

### Using the Phonebook

The KX-TGP600 has 3 types of phonebook.

1. Handset Phonebook  
This Phonebook is stored in the handset/desk phone.
2. Base unit Phonebook (when connected to a base unit other than the KX-TGP600 only)  
This Phonebook is stored in the Base unit.
3. Remote Phonebook (when connected to the KX-TGP600 only)  
If your telephone company provides the remote phonebook service, you can use it. For details, contact your phone system dealer/service provider.

	<b>Handset Phonebook</b>	<b>Base unit Phonebook</b>	<b>Remote Phonebook</b>
Storing new items	✓	✓	—
Editing stored items	✓	✓	—
Deleting store items	✓	✓	—
Searching the phonebook by name	✓	✓	✓
Searching the phonebook by category	✓	—	—
Phone numbers for each item	Up to 5	Up to 2	Up to 5*1
Private Ring	✓	—	—

\*1 This number depends on the service being used.

## Using the Handset Phonebook

You can store up to 500 phone numbers in the handset/desk phone along with names for easy access. You can also set unique ringer patterns for different categories to identify incoming calls. All Phonebook items are stored in alphabetical order. For security purposes, you can lock the Phonebook.

- To search for an item in the Phonebook, see "Searching for an Item in the Handset Phonebook", Page 66.
- To refer to another phonebook that can contain more than 500 items, see "Using the Remote Phonebook", Page 71.

### Note

- We recommend that backups are made of the handset and desk phone phonebook data, in case the data becomes unrecoverable due to product malfunction.
- A single entry (i.e., name) can have multiple phone numbers. Since the phonebook capacity is limited by the number of stored phone numbers, storing multiple phone numbers in an entry decreases the maximum number of entries.
- In addition, if your phone service provider supports the following phonebook data, you can download it via the network.  
In a name that exceeds 24 characters, the exceeding characters will be deleted.  
Phone numbers that exceed 32 digits are invalid.

## Private Ring

You can organize entries in the Phonebook into one of 9 Private Ring Categories. It is possible to set a different ringer pattern\*<sup>1</sup> for each category. When the displayed Caller ID\*<sup>2</sup> matches a phone number or name stored in the Phonebook, the handset/desk phone rings according to the Private Ring Category settings.



\*<sup>1</sup> For Ringer patterns, see "Incoming Option", Page 91.

\*<sup>2</sup> For Caller ID information, see "Caller ID", Page 52.

## Storing an Item in the Handset Phonebook

### Storing a New Item

[In standby mode]

1.  / **MENU**
2. [**▲**]/[**▼**]/[**◀**]/[**▶**]:  → **OK**
3. Enter a name (max. 24 characters). → **OK**
4. [**▲**]/[**▼**]: Select a phone number type (**1** to **5**). → **OK**
5. Enter the phone number (max. 32 digits). → **OK**
6. Repeat steps 4 and 5 to add additional phone number types.
7. [**▲**]/[**▼**]: "Category Off" → **OK**
8. Select a category. → **OK**
9. To select a default number for the entry, press [**▲**] or [**▼**] to select "Default TEL No". → **OK**
10. [**▲**]/[**▼**]: Select the number to use as the default number. → **OK**
11. **SAVE**

## Using the Phonebook

---

### Note

- Steps 7 and 8 can be omitted if you do not want to assign a category.
- Steps 9 and 10 can be omitted if you do not want to assign a default number. (The first number entered for an entry will automatically be assigned as the default number.)
- The valid digits are "0" through "9", "\*", "#", "+", "P".
- If an item with the same name and number exists, the new information added will be merged with the existing item.
- To enter characters, see "Entering Characters", Page 44.

---

### Storing an Item Using the Dialing

You can dial a number first and then add it as a phonebook entry.

#### [In standby mode]

1. Dial a number.
2. 
3. Enter a name (max. 24 characters). → **OK**
4. [▲]/[▼]: Select a phone number type (1 to 5). → **OK**
5. Edit the phone number if desired. → **OK**
6. Repeat steps 4 and 5 to add additional phone number types.
7. [▲]/[▼]: "Category Off" → **OK**
8. Select a category. → **OK**
9. To select a default number for the entry, press [▲] or [▼] to select "Default TEL No" → **OK**
10. [▲]/[▼]: Select the number to use as the default number. → **OK**
11. **SAVE**

### Note

- Steps 7 and 8 can be omitted if you do not want to assign a category.
- Steps 9 and 10 can be omitted if you do not want to assign a default number. (The first number entered for an entry will automatically be assigned as the default number.)
- The valid digits are "0" through "9", "\*", "#", "+", "P".
- If an item with the same name and number exists, the new information added will be merged with the existing item.
- To enter characters, see "Entering Characters", Page 44.

---

### Storing an Item Using the Incoming or Outgoing Call Log

You can add a number listed in the Incoming or Outgoing Call Log to the Handset Phonebook.

#### [In standby mode]

1. Display the incoming or outgoing call log. For details, see Page 41.
2. [▲]/[▼]: Select the desired item. → /MENU
3. [▲]/[▼]: "Save Phonebook" → **OK**
4. Edit the name if desired. → **OK**
5. [▲]/[▼]: Select a phone number type (1 to 5). → **OK**
6. Edit the phone number if desired. → **OK**
7. Repeat steps 5 and 6 to add additional phone number types.
8. [▲]/[▼]: "Category Off" → **OK**
9. Select a category. → **OK**



10. To select a default number for the entry, press [▲] or [▼] to select "Default TEL No" → **OK**
11. [▲]/[▼]: Select the number to use as the default number. → **OK**
12. **SAVE**



### Note

- Steps 8 and 9 can be omitted if you do not want to assign a category.
- Steps 10 and 11 can be omitted if you do not want to assign a default number. (The first number entered for an entry will automatically be assigned as the default number.)
- The valid digits are "0" through "9", "\*", "#", "+", "P".
- If an item with the same name and number exists, the new information added will be merged with the existing item.
- To enter characters, see "Entering Characters", Page 44.
- When connected to a base unit other than the KX-TGP600, a menu to select the save destination of the phonebook is displayed between steps 3 and 4.

## Editing a Stored Item in the Handset Phonebook

### Editing a Stored Item



[In standby mode]

1. 
  2. [▲]/[▼]: "Phonebook" → **OK**\*1
  3. Enter the name or the first character(s) of the desired name. → **OK**
  4. [▲]/[▼]: Select the desired item. → /MENU
  5. [▲]/[▼]: "Edit" → **OK**
  6. [▲]/[▼]: Select the desired name, phone number, category or default telephone number. → **OK**
  7. Edit the data as necessary. → **OK**
  8. Repeat step 6 to 7 and edit the items you want to change.
  9. **SAVE**
- \*1 If only Handset Phonebook is permitted, this step is skipped.

### Note

- To change a character or digit.
  1. Press [◀] or [▶] to highlight a character or digit.
  2. Delete the character or digit.

KX-TPA60:

/  [XFER/CLR]

KX-TPA65:

 / c /  / c [TRANSFER/CLEAR]

3. Enter the new character or digit.

- To clear an entire line.

KX-TPA60:

Press and hold /  [XFER/CLR] for more than 1 second.

KX-TPA65:

Press and hold  / c /  / c [TRANSFER/CLEAR] for more than 1 second.

- To move the cursor to the left or right, press [◀] or [▶], respectively.
- For details about entering characters, see "Entering Characters", Page 44.



## Using the Phonebook

---

### Editing Category Names

You can edit the names of the categories in the phonebook.

[In standby mode]

1.  /MENU
2. [▲]/[▼]/[◀]/[▶]:  → **OK**
3. [▲]/[▼]: "Display Option" → **OK**
4. [▲]/[▼]: "Category Name" → **OK**
5. [▲]/[▼]: Select the desired category number (1–9). → **OK**
6. Enter a name for the category (max. 13 characters). → **OK**
7. Repeat steps 5 and 6 for each category name to edit.

#### Note

- For details about entering characters, see "Entering Characters", Page 44.



---

## Deleting a Stored Item in the Handset Phonebook

---

### Deleting a Stored Item

[In standby mode]

1. 
2. [▲]/[▼]: "Phonebook"\*1 → **OK**
3. Enter the name or the first character(s) of the desired name. → **OK**
4. [▲]/[▼]: Select the desired item.
5.  /MENU
6. [▲]/[▼]: "Delete" → **OK**\*2
7. [▲]/[▼]: "Yes" → **OK**

\*1 If only Handset Phonebook is permitted, this step is skipped.

\*2 To delete all items, select "Delete All" instead of "Delete".

---

## Searching for an Item in the Handset Phonebook

---

You can search for an item in the phonebook by following the steps below.

### Searching by Name

You can also search for an item in the phonebook by entering a name:

[In standby mode]

1. 
2. [▲]/[▼]: "Phonebook"\*1 → **OK**
3. Enter the name or the first character(s) of the desired name. → **OK**
4. [▲]/[▼]: Select the desired item.\*2
5. Press the [CENTER]/[ENTER] navigation key.
6. [▲]/[▼]: Select the desired phone number.
7. KX-TPA60:



KX-TPA65:

Off-hook

- \*1 If only Handset Phonebook is permitted, this step is skipped.  
 \*2 If you push and hold [▲]/[▼], the next/previous items will be displayed automatically.

### Searching by Category

If items in the phonebook have been assigned categories, you can search by category.

#### [In standby mode]

- 
- [▲]/[▼]: "Phonebook"\*1 → **OK**
- [#]
- [▲]/[▼]: Select a category. → **OK**
- Enter the name of the item in the category. → **OK**
- [▲]/[▼]: Select the desired item.
- KX-TPA60:



KX-TPA65:

Off-hook

- \*1 If only Handset Phonebook is permitted, this step is skipped.

### Searching by pressing Dial Keys

You can also search for an item in the phonebook by pressing multiple dial keys when the phonebook list is displayed.

- Press the dial keys to enter the desired name in accordance with the character tables\*1.
- \*1 For details about the characters assigned to the dial keys, see the following table.

Suffix	CE/UK/AL/LA/LC/X*1/C/ (none)	CE/UK/AL/X*1	RU
Keys	ABC (Latin)	ABГ (Greek)	AБB (Cyrillic)
[1]	†→*→1	†→*→1	†→*→1
[2]	A→B→C→2	A→B→Г→2	A→Б→B→Г→2→A→B→C→2
[3]	D→E→F→3	Δ→E→Z→3	Д→E→Ё→Ж→3→3→D→E→F→3
[4]	G→H→I→4	H→Θ→I→4	И→Й→K→Л→4→G→H→I→4
[5]	J→K→L→5	K→Λ→M→5	M→H→O→П→5→J→K→L→5
[6]	M→N→O→6	N→Ξ→O→6	P→C→T→У→6→M→N→O→6
[7]	P→Q→R→S→7	Π→P→Σ→7	Ф→X→Ц→Ч→7→P→Q→R→S→7
[8]	T→U→V→8	T→Υ→Φ→8	Ш→Щ→Ъ→Ы→8→T→U→V→8
[9]	W→X→Y→Z→9	X→Ψ→Ω→9	Ъ→Э→Ю→Я→9→W→X→Y→Z→9
[0]	0→Space	0→Space	0→Space

\*1 KX-TPA65 only.

- Pressing a key repeatedly will cycle through the characters associated with that key. For example, to enter the letter "C" in Latin Mode, press [2] 3 times.
- The illustrations of the keys in the table may differ in appearance from the actual keys on the handset/desk phone.

## Using the Phonebook

---

### Character Table when searching in the Handset Phonebook

This table is only available for the dial keys when you search in the Handset Phonebook. For details about the character table for other operations, see "Character Mode Table", Page 88.

#### Example: To enter "ANNE" in Latin Mode.

[2] → [6] → [6] → [▶] → [6] → [6] → [3] → [3]

#### Note

- Availability depends on your phone system. Contact your administrator for further information.

---

## Locking the Handset Phonebook

You can lock/unlock the phonebook while the handset/desk phone is in standby mode. If no password has been set, you cannot lock the phonebook. For details about setting the password, see "Setting the Password", Page 43.

---

### Locking/Unlocking the Phonebook

#### To lock

1. Press and hold  for more than 2 seconds.  will be displayed.\*<sup>1</sup>

#### To unlock

1. Press and hold  for more than 2 seconds.
2. Enter your password.\*<sup>2</sup>
3. To return to standby mode, press

KX-TPA60:



KX-TPA65:

⊗/[CANCEL]

#### Unlocking the Phonebook Temporarily

1. 
2. Enter your password.\*<sup>2</sup>



\*<sup>1</sup> The call log is also locked.

\*<sup>2</sup> If you enter an incorrect password 3 times, you cannot enter another password for approximately 30 seconds.

## Using the Base Unit Phonebook (when connected to a base unit other than the KX-TGP600 only)

### Storing an Item in the Base Unit Phonebook

#### Storing a New Item

1.  /MENU
2. [▲]/[▼]/[←]/[→]:  → **OK**
3. [▲]/[▼]: "Base Phonebook" → **OK**
4. Enter a name (max. 24 characters). → **OK**\*1
5. [▲]/[▼]: Select a phone number type (1 to 3\*2). → **OK**
6. Enter the phone number (max. 32 digits). → **OK**
7. Repeat steps 4 and 5 to add additional phone number types.
8. **SAVE**

\*1 If the phonebook cannot be registered, "Unavailable" is displayed.



\*2 You can register up to 2 phone numbers per item.

#### Note

- The valid digits are "0" through "9", "\*", "#", "+".
- If an item with the same name and number exists, the new information added will be merged with the existing item.
- To enter characters, see "Entering Characters", Page 44.

### Editing Stored Items in the Base Unit Phonebook

#### [In standby mode]

1. 
2. [▲]/[▼]: "Base Phonebook" → **OK**
3. Enter the name or the first character(s) of the desired name. → **OK**
4. [▲]/[▼]: Select the desired item. →  /MENU
5. [▲]/[▼]: Select the desired phone number. → **OK**
6. [▲]/[▼]: "Edit" → **OK**
7. Edit the name and phone number setting as necessary.
8. **SAVE**

### Deleting Stored Items in the Base Unit Phonebook

#### Base unit Phonebook

#### [In standby mode]

1. 
2. [▲]/[▼]: "Base Phonebook" → **OK**
3. Enter the name or the first character(s) of the desired name. → **OK**

## Using the Phonebook

---

4. [▲]/[▼]: Select the desired item. → /MENU
5. [▲]/[▼]: Select the desired phone number. → **OK**
6. [▲]/[▼]: "Delete" → **OK**\*1
7. [▲]/[▼]: "Yes" → **OK**

\*1 In step 6, you can select "Delete All" instead to delete all items.

---



## Searching for an Item in the Base Unit Phonebook

---

### Searching by Name

You can also search for an item in the phonebook by entering a name:

#### [In standby mode]

1. 
2. [▲]/[▼]: "Base Phonebook" → **OK**
3. Enter the name or the first character(s) of the desired name. → **OK**
4. [▲]/[▼]: Select the desired item. → /MENU\*1.
5. [▲]/[▼]: Select the desired phone number.
6. KX-TPA60:



KX-TPA65:

Off-hook

\*1 If you push and hold [▲]/[▼], the next/previous items will be displayed automatically.

## Using the Remote Phonebook (when connected to the KX-TGP600 only)

You can refer to the Remote Phonebook in addition to the Handset Phonebook, if the Remote Phonebook is available.

### Note

- We recommend setting this feature with your administrator. Contact your administrator for further information.

## Searching for an Item in the Remote Phonebook

### Searching by Name

You can also search for an item in the phonebook by entering a name:

[In standby mode]

1. 
2. [▲]/[▼]: "Remote Phonebook"\*1. → **OK**
3. Enter the name or the first character(s) of the desired name. → **OK**
4. [▲]/[▼]: Select the desired item. → **OK**\*2
5. [▲]/[▼]: Select the desired phone number.
6. KX-TPA60:



KX-TPA65:

Off-hook



- \*1 If only Remote Phonebook is permitted, this step is skipped.  
 \*2 If you push and hold [▲]/[▼], the next/previous items will be displayed automatically.

# Customizing the Telephone

---

## Changing the Handset Number and Name Display

You can change the display of the handset's number and name when the handset/desk phone is in standby mode.

1.  /MENU
2. [▲]/[▼]/[◀]/[▶]:  → **OK**
3. [▲]/[▼]: "Display Option" → **OK**
4. [▲]/[▼]: "Standby Display" → **OK**
5. [▲]/[▼]: Select the desired item. → **OK**

---

## Hot Keys

By assigning phone numbers to dial keys, you can make a call by pressing and holding a dial key.

- "Hot Key Dialing", Page 48

---

## Assigning Hot Keys From Phonebook

You can assign a phone number stored in the Handset Phonebook to a key to be used as a Hot Key.

1. In standby mode, press and hold a dial key (0–9) for more than 1 second.
2.  /MENU
3. [▲]/[▼]: Select "Copy from P.book". → **OK**
4. Enter the desired name. → **OK**
5. [▲]/[▼]: Select a number → **OK**
6. "Save" → **OK**

### Note

- For details about searching for an item in the phonebook, see "Searching for an Item in the Handset Phonebook", Page 66.

---

## Editing Hot Keys

1. In standby mode, press and hold a dial key (0–9) for more than 1 second.
2.  /MENU
3. [▲]/[▼]: "Edit" → **OK**
4. Edit the Hot Key Name, if necessary. → **OK**
5. Edit the Hot Key Number, if necessary. → **OK**
6. "Save" → **OK**

---

## Deleting a Hot Key

1. In standby mode, press and hold the dialing key assigned as a Hot Key for more than 1 second.\*1
2.  /MENU
3. [▲]/[▼]: "Delete" → **OK**\*2
4. [▲]/[▼]: "Yes" → **OK**



- \*1 While the Hot Key's information is displayed, you can press [▲] or [▼] to select another Hot Key number.
- \*2 To delete all items, select "Delete All" instead of "Delete".

---

### Selecting the Type of Hot Key Dialing

You can select one of 2 types of Hot Key Dialing for each assigned Hot Key.

1. In standby mode, press and hold a dial key (0–9) for more than 1 second.
2.  /MENU
3. [▲]/[▼]: "Automatic Call" → **OK**
4. "Manual"/"Auto" → **OK**
  - Manual:  
Performing the dialing operation makes a call to the number assigned to the Hot Key. For details, see "Hot Key Dialing", Page 48.
  - Auto:  
Pressing and holding an assigned Hot Key for the set number of seconds will dial that Hot Key's assigned number immediately.

#### Note

- To select the number of seconds before the call is automatically made, see "Hot Key Time" in "Key Option", Page 93.

---

### Memo Alarm Setting

An alarm will sound at the set time. A memo can also be displayed. Memo Alarm is available only when the handset/desk phone is within range of a base unit.



#### Note

- You can select the ringer pattern for each Memo Alarm. For details, see "Incoming Option", Page 91.
- If you are on a call at the time that the alarm is set to sound, it will sound after you have ended the call.

---

### Setting a Memo Alarm

[In standby mode]

1.  /MENU
2. [▲]/[▼]/[◀]/[▶]:  → **OK**
3. [▲]/[▼]: Select an alarm number (1–3). → **OK**
4. [▲]/[▼]: Select an alarm mode. → **OK**

The alarm modes are as follows:

  - Off: Disables the selected Memo Alarm.
  - Once: The selected Memo Alarm will occur only once.
  - Daily: The selected Memo Alarm will occur at the same time every day.
  - Weekly: The selected Memo Alarm will occur at the same time on selected days of the week.
5. Set the time and date for the Memo Alarm. The information to enter depends on the alarm mode.
  - Once: Enter the date and time, using the Navigator Keys and/or dial keys. → **OK**
  - Daily: Enter the daily time, using the Navigator Keys and/or dial keys. → **OK**
  - Weekly:
    - a. [▲]/[▼]: Select a day of the week. → 
    - A ✓ mark will be displayed next to each day of the week that has been selected. In this way, you can select multiple days of the week.
    - b. After selecting 1 or more days of the week. → **OK**

## Customizing the Telephone

---

- c. Enter a time of day using the Navigator Keys and/or dial keys. → **OK**
6. Enter a text message to be displayed when the Memo Alarm occurs. → **OK**
7. **OK**
8. "Save" → **OK**



### Note

- For details about entering characters, see "Entering Characters", Page 44.
- When entering a time of day, press [AM/PM] to toggle between AM or PM. [AM/PM] will not be displayed if 24-hour-time display is set.

---

### Deleting a Memo Alarm





#### [In standby mode]

1. /MENU
2. [▲]/[▼]/[◀]/[▶]:  → **OK**
3. [▲]/[▼]: Select an alarm number (1–3). → **DELETE**/
4. [▲]/[▼]: "Yes" → **OK**

---

### Stopping a Memo Alarm



#### [While the alarm is ringing]

1. KX-TPA60:  
 or //[XFER/CLR], , or set the handset on the charger
- KX-TPA65:  
/[CANCEL], /c//c/[TRANSFER/CLEAR] or 

---

## Changing the Function Keys

#### [In standby mode]

1. /MENU
2. [▲]/[▼]/[◀]/[▶]:  → **OK**
3. [▲]/[▼]: "Key Option" → **OK**
4. [▲]/[▼]: "Function Key" → **OK**
5. [▲]/[▼]: Select the item to change. → **OK**\*1
6. [▲]/[▼]: Select the new item to assign. → **OK**\*1

\*1 To scroll down, press **NEXT**.

### Note

- You can assign the same function to multiple dial keys.
- You must assign a function to each key.

---

## Changing the Handset Default Settings

#### To select the main item in standby mode

1. /MENU

2. [▲]/[▼]/[←]/[→]:  → **OK**
3. [▲]/[▼]: Select the main item. → **OK**



Main Item	Sub Item			Page
Incoming Option	Ringer Volume	Ringer Type	Ring On Charger	Page 91
	Memo Alarm	Power Save	Headset Ringer	
Talk Option	Noise Reduction/ Voice Clarity	Speaker Volume	Receiver Volume	Page 92
	Headset Volume	Headset Mic Vol	Talk On Charger	
	Equalizer			
Answer Option	Any Key Answer	Quick Answer	Auto Answer	Page 92
	Auto Ans Delay			
Key Option	Function Key	Soft Key Edit	Soft Key Name	Page 93
	Key Lock Type	Auto Lock Time	Hot Key Time	
Display Option	Language	Backlight	LCD Brightness	Page 95
	Standby Display	Handset Name	Category Name	
	Date Format	Time Format	Caller ID Disp	
	Colour Scheme/Color Scheme	Base Monitor		
Tone Option	Key Tone	Range Alarm		Page 96
System Option	Register H/S	Cancel Base	Select Base	Page 96
	System Lock	Change PIN	H/S Information	
Other Option	Change Password	Reset Handset	Embedded Web	Page 97

## Changing the System Default Settings

### IMPORTANT

- The feature depends on your phone system. Contact your administrator for further information.

[In standby mode]

1. /MENU
2. [▲]/[▼]/[←]/[→]:  → **OK**
3. [▲]/[▼]: Select the main item. → **OK**

Main Item	Sub Item			Page
Status	Line Status	Firmware Version	IP Mode	Page 98
	IPv4 Settings	IPv6 Settings	MAC Address	
	LLDP	VLAN		
Network Settings	IP Mode Select	IPv4 Settings	IPv6 Settings	Page 98
	LLDP	VLAN	Link Speed	

## Customizing the Telephone



Main Item	Sub Item			Page
System Settings	Register H/S	Cancel Register	Change Base PIN	Page 99
	Set Time & Date	Repeater Mode	MultilineSetting	
	Authentication	Access Code	Xsi Setting	
	UC Setting	Parallel Setting		
Call Settings	Block Anonymous	Anonymous Call	Block Caller ID	Page 100
	Anywhere	Remote Office	SimultaneousRing	

### Block Anonymous Calls (when connected to the KX-TGP600 only)

This feature allows the unit to reject calls when the unit receives a call without phone number. The default setting is "Off".

#### IMPORTANT

- We recommend setting with your administrator. Contact your administrator for further information.
- This feature is not available on shared lines.

1. /MENU
2. [▲]/[▼]/[◀]/[▶]:  → **OK**
3. [▲]/[▼]: "Call Settings" → **OK**
4. [▲]/[▼]: "Block Anonymous" → **OK**
5. [▲]/[▼]: Select a desired line. → **OK**
6. [▲]/[▼]: "On"/"Off" → **OK**



### Incoming Call Barring (Caller ID service users only)

This feature allows the unit to reject calls from specified phone numbers that you do not want to answer such as junk calls.

When a call is received, the unit does not ring while the caller is being identified. If the phone number matches an entry in the call barred list, the unit rejects the call.



### Storing unwanted callers (when connected to the KX-TGP600 only)

You can store up to 20 phone numbers per line in the call barred list by using the caller list or by entering the numbers directly.



1. /MENU
2. [▲]/[▼]/[◀]/[▶]:  → **OK**
3. [▲]/[▼]: "Call Settings" → **OK**
4. [▲]/[▼]: "Block Caller ID" → **OK**
5. [▲]/[▼]: Select a desired line. → **OK**
6. [▲]/[▼]: Select a blank line. → **OK**
7. Enter the phone number (32 digits max.). → **OK**

### Editing the phone numbers to reject (when connected to the KX-TGP600 only)

1. /MENU

2. [▲]/[▼]/[◀]/[▶]:  → **OK**
3. [▲]/[▼]: "Call Settings" → **OK**
4. [▲]/[▼]: "Block Caller ID" → **OK**
5. [▲]/[▼]: Select a desired line. → **OK**
6. [▲]/[▼]: Select a desired phone number. → /MENU
7. [▲]/[▼]: "Edit" → **OK**
8. Enter the phone number. → **OK**

#### Deleting the phone numbers to reject (when connected to the KX-TGP600 only)

1. /MENU
2. [▲]/[▼]/[◀]/[▶]:  → **OK**
3. [▲]/[▼]: "Call Settings" → **OK**
4. [▲]/[▼]: "Block Caller ID" → **OK**
5. [▲]/[▼]: Select a desired line. → **OK**
6. [▲]/[▼]: Select a desired phone number. → /MENU
7. [▲]/[▼]: "Delete Number"<sup>\*1</sup> → **OK**
8. [▲]/[▼]: "Yes" → **OK**



\*1 To delete all items, select "Delete All No." instead of "Delete Number".

#### Making an Anonymous Call (when connected to the KX-TGP600 only)

Before making a call, specify the following:

##### IMPORTANT

- We recommend setting with your administrator. Contact your administrator for further information.

1. /MENU
2. [▲]/[▼]/[◀]/[▶]:  → **OK**
3. [▲]/[▼]: "Call Settings" → **OK**
4. [▲]/[▼]: "Anonymous Call" → **OK**
5. [▲]/[▼]: Select a line. → **OK**
6. [▲]/[▼]: "On"/"Off" → **OK**

#### Web User Interface Programming

The product provides a Web-based interface for configuring various settings and features, including some that are not programmable directly from the handset/desk phone. The following list contains some useful features that are programmable through the Web user interface.

Contact your administrator for further information.

- Web Language
- User Password (for access to Web user interface)
- Handset Basic Settings
- Grouping Handset / Handset select for receiving call

## ***Customizing the Telephone***

---

- Handset and Line Number select for making call
- Phonebook import and export

### **Note**

- Each time you want to access the Web user interface, you must enable Web programming (Embedded Web). See “Other Option”, Page 97.

---

## Installation and Setup

### Note

- Panasonic assumes no responsibility for injuries or property damage resulting from failures arising out of improper installation or operation inconsistent with this documentation.

### WARNING

- To reduce the risk of fire or electric shock, do not overload AC outlets and extension cords.
- Completely insert the AC adaptor/power plug into the AC outlet. Failure to do so may cause electric shock and/or excessive heat resulting in a fire.
- Regularly remove any dust, etc. from the AC adaptor/power plug by pulling it from the power outlet, then wiping with a dry cloth. Accumulated dust may cause an insulation defect from moisture, etc. resulting in a fire.

---

### Attaching the Stand (KX-TPA65)

Attach the stand to the desk phone.

1. Insert the stand into the hooks located in the unit.
2. Gently rotate the stand in the direction indicated until it is released.

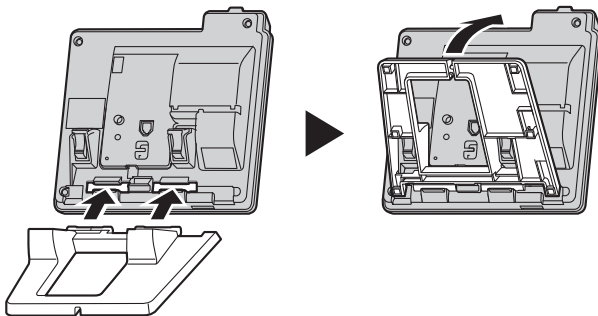

---

### Adjusting the Stand Position (KX-TPA65)

Push the PUSH marks in the direction indicated, with both hands, and tilt the stand until it becomes fixed in the desired position.

## Installation and Setup

---

- High Position → Low Position

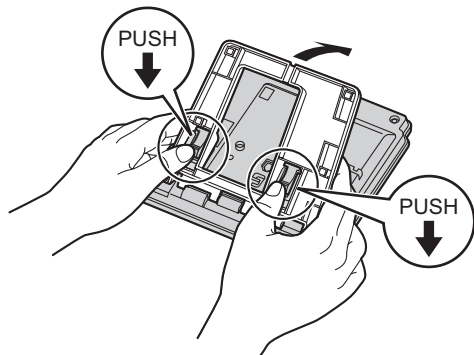

- Low Position → High Position

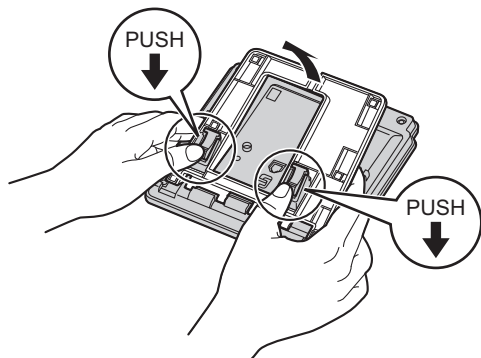

---

## Removing the Stand (KX-TPA65)

Tilt the stand in the direction indicated while pushing the PUSH marks with both hands.

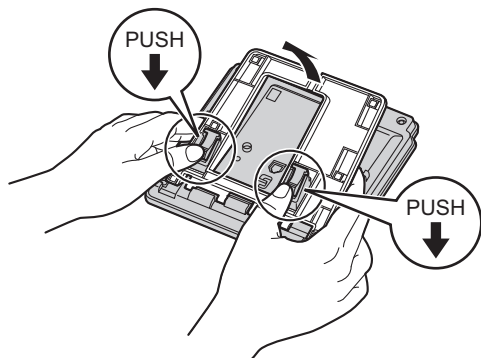



## Connections

### KX-TPA65 (Desk phone)

Attach the AC adaptor, corded handset and headset to the desk phone.

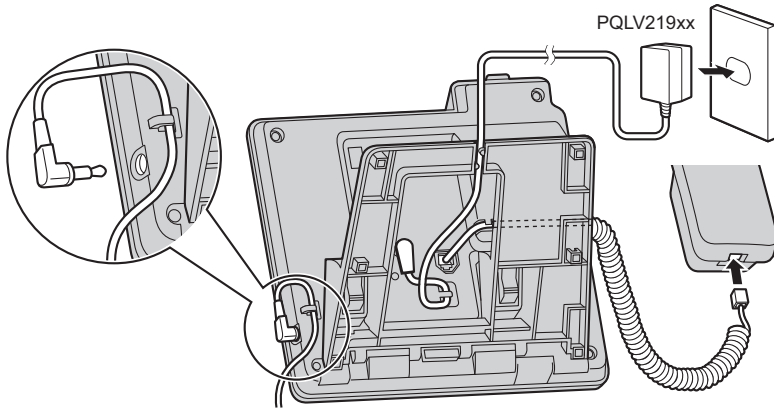

### KX-TGP600 (Base unit)

Connect the AC adaptor and the Ethernet cable to the base unit.

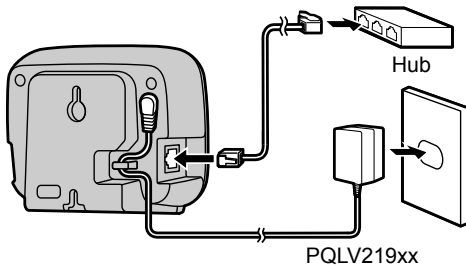

- The initial setting for the KX-TGP600 IP address is "DHCP—Auto". For information about your network environment, contact your administrator. For details, see "Network Settings", Page 98.

### Charger for KX-TPA60

Connect the AC adaptor to the charger.

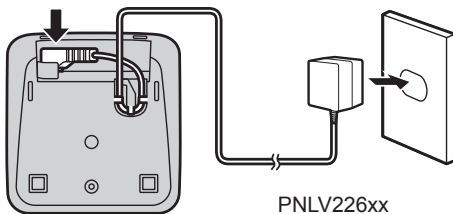

## Installation and Setup

---

- The AC adaptor should be connected to a vertically oriented or floor-mounted AC outlet. Do not connect the AC adaptor to a ceiling-mounted AC outlet, as the weight of the adaptor may cause it to become disconnected.
- Fasten the AC adaptor cord to the cord holder.
- Use only the included Panasonic AC adaptor.

## Battery Installation

---

Open the battery cover, insert the batteries, and close the cover as indicated below.

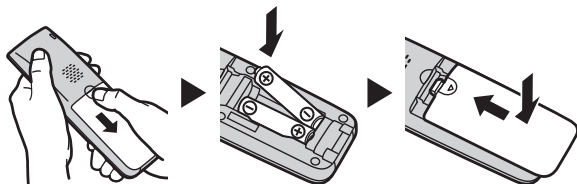

## Attaching the Belt Clip

---

You can attach the handset to your belt by following the steps below.

1. Push the clip onto the back of the handset.
2. Insert the clip into the designated notches in the handset.

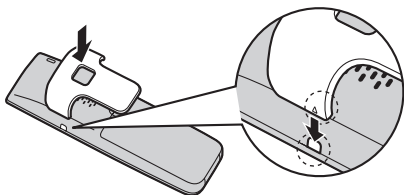

## Charging the Batteries

---

At the time of shipment, the batteries are not charged. Please charge the batteries for about 6 hours before using the handset for the first time.

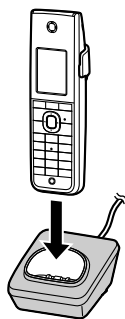

- The charge indicator will turn off when the batteries are fully charged. For more information about charging batteries, see "Battery Information", Page 11.
- It is normal for the handset and charger to feel warm while the batteries are charging.
- Keep devices sensitive to magnetic fields away from the charger.
- Use only the included charger.

## Wall Mounting

### Note

- Make sure that the wall and the fixing method are strong enough to support the weight of the unit.

### KX-TGP600 (Base unit)

1. Drive the screws into the wall either 55 mm (2 5/32 in) apart, and mount the unit on the wall.

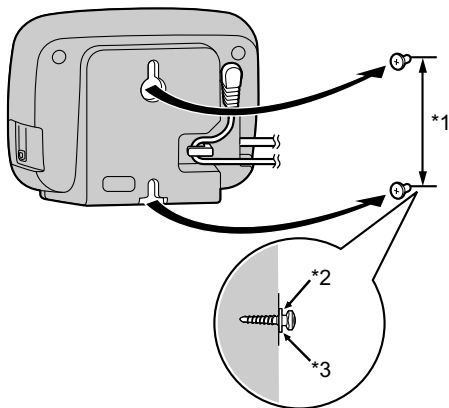

\*1 55 mm (2 5/32 in)

\*2 Washer

\*3 Drive the screw to this point.

### KX-TPA65 (Desk phone)

1. Connect the handset cord.
2. Insert the tabs of the wall mounting adaptor into the designated openings in the base, and then slide the wall mounting adaptor in the direction of the arrow until it clicks.

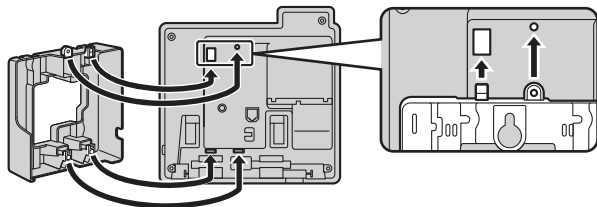

3. Fasten the wall mounting adaptor to the base with the screw.  
(Recommended torque: 0.4 N·m [4.08 kgf·cm/3.54 lbf·in] to 0.6 N·m [6.12 kgf·cm/5.31 lbf·in])
4. Connect the AC adaptor.

## Installation and Setup

- Drive the screws into the wall either 83 mm (3 1/4 in) or 100 mm (3 15/16 in) apart, and mount the unit on the wall.

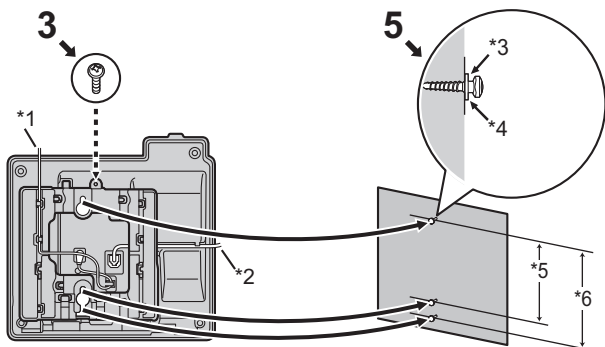

\*1 AC adaptor

\*2 Handset Cord

\*3 Washer

\*4 Drive the screw to this point.

\*5 83 mm (3 1/4 in)

\*6 100 mm (3 15/16 in)

- You can find a wall mounting template at the end of this manual.
- When inserting screws, avoid pipes and electrical cables, etc., that may be present/buried.
- The screw heads should not be flush to the wall.
- Certain types of wall may require plugs to be anchored in the wall before the screws are inserted.

---

### Hooking the Handset (KX-TPA65)

#### To Hook the Handset During a Conversation

- Hook the handset over the top edge of the unit.

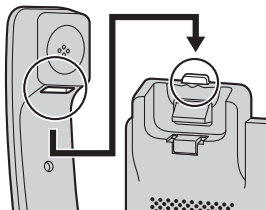

#### To Lock the Handset Hook when the Unit is Wall Mounted

##### KX-TPA65 (Desk Phone)

- Remove the handset hook from the slot.
- Turn it up-side-down.
- Slide the handset hook back into the slot until it locks.

4. Handset is safely hooked when it is in the cradle.

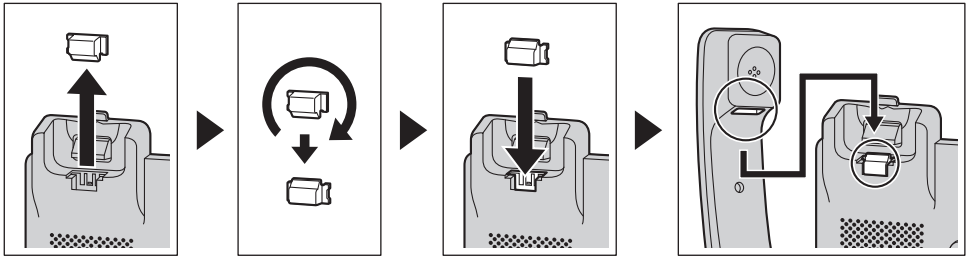

---

## Updating the Software

When the base unit requests to update the handset/desk phone software, the handsets/desk phones registered to the base unit will start their software update automatically.

---

### Updating the Handset/Desk Phone Software

The following handsets/desk phones can update their own software, which can be downloaded through the KX-TGP600 automatically:

- KX-TPA60
- KX-TPA65
- KX-UDT series (except for KX-UDT111)

After the base unit requests to start downloading the handset/desk phone software, you cannot enter any keys.

The update is performed automatically. Follow the instructions on the LCD and wait until the update finishes.

#### Note

- If you failed in the update, contact your administrator.

---

## Registering/Deregistering a Handset/Desk Phone to the KX-TGP600

---

### Registering a Handset/Desk Phone to the KX-TGP600

You can register a handset/desk phone to up to 4 base units.

You can register a base unit to up to 8 handsets/desk phones (KX-TPA60/KX-TPA65/KX-UDT series).

There are 2 types of registration method.

- Handset/desk phone registration using the base unit
- Handset/desk phone registration using the handset/desk phone

The supplied handset/desk phone and base unit are preregistered. If for some reason the handset/desk phone is not registered to the base unit (for example, the signal strength is out of range even when the handset/desk phone is near the base unit), re-register the handset/desk phone.





---

#### Handset/desk phone registration using the base unit

When adding a new handset/desk phone:

## Installation and Setup





---

1. Base unit:
  - a. Press and hold the handset locator button for about 3 seconds.  
The STATUS indicator on the base unit will flash red (slow flashing).
2. Unregistered handset/desk phone:  
[When adding a new handset/desk phone]
  - Easy registration  
In standby mode, press and hold **OK** until displaying "Please Wait...".  
After "Registered" displayed on the LCD, the registration is completed.  
From step a to step e can be skipped.  
[When registering a handset/desk phone to another base unit]
  - Normal registration
    - a. /MENU
    - b. :  → **OK**
    - c. : "System Option" → **OK**
    - d. : "Register H/S" → **OK**
    - e. Select a base unit. → **OK**  
After "Registered" is displayed on the LCD, the registration is completed.
  - If 4 base units have been registered to a handset/desk phone, "Memory Full" is displayed on the LCD at step d.

---

### Handset/desk phone registration using the handset/desk phone





If operation using the base unit is difficult, or if you want to specify the handset/desk phone number during registration, you can use a registered handset/desk phone to add new handsets/desk phones. Before operating the handset/desk phone, confirm that the STATUS indicator of the base unit is Green (On/Slow Flashing/Quick Flashing).

1. Registered handset/desk phone:
  - a. /MENU
  - b. :  → **OK**
  - c. : "System Settings" → **OK**
  - d. : "Register H/S" → **OK**
  - e. Select a handset/desk phone. → **OK**  
If more than 5 handsets/desk phones are registered, you can press **NEXT** to scroll down.  
The STATUS indicator on the base unit will flash red (slow flashing).
2. Unregistered handset/desk phone:  
Follow the procedure from step 2 above with the handset/desk phone you want to add.

---

### Deregistering a Handset/Desk Phone

A handset/desk phone can cancel its own registration (or the registration of another handset/desk phone) that is stored to the base unit. This allows the handset/desk phone to end its wireless connection with the system.

1. Handset/desk phone:  
In standby mode, press /MENU, and then press  and  to select "System Settings". → **OK**
2. Handset/desk phone:  
: "System Settings" → **OK**

3. Handset/desk phone:  
[▲]/[▼]: "Cancel Register" → **OK**
4. Handset/desk phone:  
Select a handset/desk phone. → **OK**

---

### Registering/Deregistering the Handset/Desk Phone to a Base Unit Other than the KX-TGP600

---

#### Registering the handset/desk phone

The base unit operations/settings should be performed according to the base unit's instructions.

---



#### Handset/desk phone registration using the base unit

1. Base unit:  
Enter handset/desk phone registration mode.
2. Handset/desk phone:  
Using an unregistered handset/desk phone, press **OK** and follow the on-screen instructions until registration is complete.

---

#### Deregistering the handset/desk phone

A handset/desk phone can delete its own registration (or the registration of another handset/desk phone) stored on the base unit. This allows the handset/desk phone to end its wireless connection with the system.

1. /MENU
2. [▲]/[▼]/[◀]/[▶]:  → **OK**
3. [▲]/[▼]: "System Settings" → **OK**
4. [▲]/[▼]: "Intercom List" → **OK**
5. [▲]/[▼]: "Handset" → **OK**
6. [▲]/[▼]: "Delete" → **OK**
7. [▲]/[▼]: "Yes"/"No" → **OK**

# Appendix

## Character Mode Table

KX-TPA60/KX-TPA65 (Suffix: [none/C])

Keys	ABC (Latin)		0–9 (Numeric)	+ÄÄ (Extended 1)	
	Upper	Lower		Upper	Lower
[1]	Space † & ' ( ) * , - . / 1		1	Space † & ' ( ) * , - . / 1	
[2]	A B C 2	a b c 2	2	À Á Â Ã Ä Å Æ B C Ç 2	à á â ã ä å æ b c ç 2
[3]	D E F 3	d e f 3	3	Ð Æ È É Ê Ë Ì 3	ð Æ è é ê ë ì 3
[4]	G H I 4	g h i 4	4	Ĝ Ĥ Ħ Ĩ Ĵ Ķ Ĺ 4	ĝ ĥ ħ ĩ ĵ ķ ĳ 4
[5]	J K L 5	j k l 5	5	J K L 5	j k l 5
[6]	M N O 6	m n o 6	6	M Ñ Ń Ő Ó Ô Ō Ő ø œ 6	m ñ ñ ő ó ô õ ø œ 6
[7]	P Q R S 7	p q r s 7	7	P Q R S Ŝ ß 7	p q r s ŝ ß 7
[8]	T U V 8	t u v 8	8	T U Û Ü Ú Û Ü V 8	t u ù ú û ü v 8
[9]	W X Y Z 9	w x y z 9	9	W Ŵ X Y Ŷ Z 9	w ŵ x y ŷ z 9
[0]	Space ! ? " : ; + = < > 0		0	Space ! ? " : ; + = < > 0	
[#]	\$ % & @ € £		#	\$ % & @ € £	

- To change between uppercase and lowercase before or after entering a character, press KX-TPA60:



KX-TPA65:



- Pressing a key repeatedly will cycle through the characters associated with that key. For example, to enter the letter "C" in Latin Mode, press [2] 3 times.
- Characters that are entered using the [#] key (for example, "\$") cannot be entered when searching the phonebook. See "Searching for an Item in the Handset Phonebook", Page 66.
- The illustrations of the keys in the table may differ in appearance from the actual keys on the handset/desk phone.

KX-TPA60/KX-TPA65 (Suffix: CE/UK/AL/LA/LC/X)

Keys	ABC (Latin)	0–9 (Numeric)	ΑΒΓ (Greek)	ÄÄÄ (Extended 1)	ŠŠŠ (Extended 2)
[1]	Space † & ' ( ) * , - . / 1		Space † & ' ( ) * , - . / 1		
[2]	A B C 2	2	Α Β Γ 2	À Á Â Ã Ä Å Æ B C Ç 2	Á Ä Å Æ B C Č Ć 2
	a b c 2		α β γ 2	à á â ã ä å æ b c ç 2	á á ä å æ b c č ě 2



Keys	ABC (Latin)	0–9 (Numeric)	ΑΒΓ (Greek)	ΑĂĂ (Extended 1)	ŚŚŚ (Extended 2)
[3]	DEF3	3	ΔΕΖ3	DĐEĚÉÊËĔĕF3	DĎĚĚĚĚĚF3
	def3		δεζ3	dďeěéêëĕf3	dďeěěĕĕf3
[4]	GHI4	4	ΗΘΙ4	GĜHIÍĪĴĴĴĴ4	GHIÍ4
	ghi4		ηθι4	gĝhiíĵĵĵĵ4	ghii4
[5]	JKL5	5	ΚΛΜ5	JKL5	JKLŁŁŁ5
	jkl5		κλμ5	jkl5	jklll5
[6]	MNO6	6	ΝΞΟ6	MNŃOOÓÔ Ö Ø œ 6	MNŃŃOOÓ Ŏ 6
	mno6		νξο6	mñńoóóô ø œ 6	mnnńoóóô6
[7]	PQRS7	7	ΠΡΣ7	PQRSŞß7	PQRŔŖSŚŞ7
	pqrs7		πρσ7	pqrşşß7	pqrŕŕśśś7
[8]	TUV8	8	ΤΥΦ8	TUÛÚŪŪŪŪV8	TŤŤUŪŪŪŪŪV8
	tuv8		τυφ8	tuúúúúŭv8	tťťuúúúŭv8
[9]	WXYZ9	9	ΧΨΩϣ9	WŴXYŶZ9	WXYŸŸZZŽŽ9
	wxyz9		χψωϣ9	wŵxyŷz9	wxyÿÿzzžž9
[0]	Space ! ? " : ; + = < > 0	0	Space ! ? " : ; + = < > 0		
[#]	\$ % & @ € £	#	\$ % & @ € £		

\*1 KX-TPA65 only.

- To change between uppercase and lowercase before or after entering a character, press KX-TPA60:



KX-TPA65:



- Pressing a key repeatedly will cycle through the characters associated with that key. For example, to enter the letter "C" in Latin Mode, press [2] 3 times.
- Characters that are entered using the [#] key (for example, "\$") cannot be entered when searching the phonebook. See "Searching for an Item in the Handset Phonebook", Page 66.
- The illustrations of the keys in the table may differ in appearance from the actual keys on the handset/ desk phone.

#### KX-TPA60/KX-TPA65 (Suffix: RU)

Keys	АБВ (Cyrillic)	0–9 (Numeric)	ABC (Latin)	АĂĂ (Extended 1)	ŚŚŚ (Extended 2)
[1]	Space Ѡ ѡ & ' ( ) * , - . / 1	1	Space Ѡ ѡ & ' ( ) * , - . / 1		

## Appendix

Keys	АБВ (Cyrillic)	0-9 (Numeric)	ABC (Latin)	AĂĂ (Extended 1)	SŠŠ (Extended 2)
[2]	АБВГ2	2	ABC2	AĂĂĂĂĂĂĂ ÆBCÇ2	AĂĂĂĂBCČČ2
	абвг2		abc2	aăăăăăăă æbcç2	aăăăăabcčč2
[3]	ДЕЁЖЗ3	3	DEF3	DÐEÊÉÊËËF3	DĐEĚÉĚĚF3
	деёжз3		def3	dðeèéèëëf3	dďeěěěěf3
[4]	ИЙКЛ4	4	GHI4	GĞHIÍĪĪĪĪĪ4	GHIÍ4
	ийкл4		ghi4	gğhiíĭĭĭĭĭ4	ghii4
[5]	МНОП5	5	JKL5	JKL5	JKLŁŁŁ5
	мноп5		jkl5	jkli5	jklił5
[6]	РСТУ6	6	MNO6	MNŃOÒÓÔ ÖÖøŒ6	MNŃŃŃOÓŌ ŌŌ6
	рсту6		mno6	mñňoòóôö øœ6	mñńňñoóôö6
[7]	ФХЦЧ7	7	PQRS7	PQRSŞß7	PQRŔŔŔSŠŠ7
	фхцч7		pqr7	pqrşşß7	pqrŕŕŕsšš7
[8]	ШЩЪЫ8	8	TUV8	TUÛÚÚÛÛÛÛ8	TŤŤUÚÚÚÚÛ8
	шщъы8		tuv8	tuúúúúúÛ8	tťťuúúúúÛ8
[9]	ЪЭЮЯГЄІІ Ÿ9	9	WXYZ9	WŴXYŶZ9	WXYŸYZŽŽŽ9
	ъэюягєіі ÿ9		wxyz9	wŵxyÿz9	wxyÿýzžžž9
[0]	Space ! ? " : ; + = < > 0	0	Space ! ? " : ; + = < > 0		
[#]	\$ % & @ € £	#	\$ % & @ € £		

- To change between uppercase and lowercase before or after entering a character, press KX-TPA60:



KX-TPA65:



- Pressing a key repeatedly will cycle through the characters associated with that key. For example, to enter the letter "C" in Latin Mode, press [2] 3 times.
- Pressing a key repeatedly will cycle through the characters associated with that key. For example, to enter the letter "B" in Cyrillic Mode, press [2] 3 times.
- Characters that are entered using the [#] key (for example, "\$") cannot be entered when searching the phonebook. See "Searching for an Item in the Handset Phonebook", Page 66.
- The illustrations of the keys in the table may differ in appearance from the actual keys on the handset/desk phone.

## Handset Setting Menu Layout

### Incoming Option

Sub Item	Description	Setting	Default
Ringer Volume	Adjusts the ringer volume	<input type="checkbox"/> Step Up <input type="checkbox"/> Step Down <input type="checkbox"/> Level 1–6 <input type="checkbox"/> Off	Level 3
Ringer Type (when using a KX-TGP600) <ul style="list-style-type: none"> <li>● Line 1–8</li> <li>● Intercom Ring</li> <li>● Private Ring (Category 1–9)</li> </ul>	Ringer Pattern Selects the ringtone for each type of call.*1	<input type="checkbox"/> Ringtone 1–19, 25–32	Line 1–8: Ringtone 1–8 Intercom Ring: Ringtone 9 Private Ring: Ringtone 1
	Colour Pattern/Color Pattern*2 Selects the color pattern for each type of call.	<input type="checkbox"/> Normal <input type="checkbox"/> Yellow <input type="checkbox"/> Red	Normal
Ringer Type (when using a base unit other than the KX-TGP600) <ul style="list-style-type: none"> <li>● External Ring</li> <li>● Intercom Ring</li> <li>● Private Ring (Category 1–9)</li> </ul>	Ringer Pattern Selects the ringtone for each type of call.*1	External Ring <input type="checkbox"/> Pattern 1–7	—
		Intercom Ring <input type="checkbox"/> Ringtone 1–19, 25–32	—
	Colour Pattern/Color Pattern*2 Selects the color pattern for each type of call.	<input type="checkbox"/> Normal <input type="checkbox"/> Yellow <input type="checkbox"/> Red	—
Ring On Charger (KX-TPA60 only)	Selects the ringing mode (On or Off) while a handset is set on the charger.*3	<input type="checkbox"/> On <input type="checkbox"/> Off	On
Memo Alarm	Ringer Pattern Selects the ringtone for each Memo Alarm.	<input type="checkbox"/> Ringtone 1–19, 25–32	
Power Save (KX-TPA60 only)	Power Save Time Selects the number of seconds before automatically turning off the Power Save Items below when receiving a call.	0s–60s	30s
	Power Save Item Selects the items to turn off.	<input type="checkbox"/> Ringer <input type="checkbox"/> Backlight	Not selected
Headset Ringer	Selects whether a tone is heard from the connected headset while receiving a call.	<input type="checkbox"/> On <input type="checkbox"/> Off	Off

\*1 The preset melodies in this product are used with permission of © 2010 Copyrights Vision Inc.

\*2 Displayed only when "Private Ring" is selected.

\*3 When "Ring On Charger" is set to "On" but "Ringer Volume" is set to "Off", the handset rings at level 1.

## Appendix

### Talk Option

Sub Item	Description	Setting	Default
Noise Reduction/ Voice Clarity (KX-TPA60 only)	Activate/deactivate Noise Reduction.	<input type="checkbox"/> On <input type="checkbox"/> Off	Off
Speaker Volume	Adjusts the rear speaker volume.	Level 1–6	Level 3
Receiver Volume	Adjusts the receiver volume.	Level 1–6	Level 2
Headset Volume	Adjusts the headset speaker volume.	Level 1–6	Level 2
Headset Mic Vol	Adjusts the headset microphone volume.	Level 1–6	Level 6
Talk On Charger (KX-TPA60 only)	Selects whether or not to continue the conversation when the handset is put on the charger during a conversation.	<input type="checkbox"/> On <input type="checkbox"/> Off	Off
Equalizer	Adjusts the upper register of the receiver.+++++	<input type="checkbox"/> Normal <input type="checkbox"/> Treble	Normal

### Answer Option

Sub Item	Description	Setting	Default
Any Key Answer (KX-TPA60 only)	Answers a call by pressing any dialing key.	<input type="checkbox"/> On <input type="checkbox"/> Off	Off
Quick Answer (KX-TPA60 only)	Answers a call while the phone is charging by just lifting up a handset from the charger.	<input type="checkbox"/> On <input type="checkbox"/> Off	Off
Auto Answer	Selects the types of calls that can be answered by Auto Answer.	<input type="checkbox"/> Internal Only/Int Only <input type="checkbox"/> Int&External/Int & CO	Int&External/Int & CO
Auto Ans Delay	Selects the number of seconds before a call is automatically answered when Auto Answer is turned on.	0s–20s	6s

## Key Option

Sub Item	Description	Setting	Default
Function Key	Edits the Function Key list.	<b>Suffix: CE/UK/AL/RU/LA/LC</b> <input type="checkbox"/> Redial <input type="checkbox"/> Fwd/DND* <sup>1</sup> <input type="checkbox"/> Conference <input type="checkbox"/> Auto Answer <input type="checkbox"/> Flash/Recall <input type="checkbox"/> Incoming Log <input type="checkbox"/> Outgoing Log <input type="checkbox"/> Phonebook <input type="checkbox"/> Call Park* <sup>2</sup> * <sup>3</sup> <input type="checkbox"/> Intercom <input type="checkbox"/> Pause* <sup>3</sup> <input type="checkbox"/> Alarm <input type="checkbox"/> Noise Reduction/Voice Clarity* <sup>4</sup> <input type="checkbox"/> Paging* <sup>2</sup> * <sup>3</sup> <input type="checkbox"/> None	1: Redial 2: Fwd/DND* <sup>1</sup> 3: Conference 4: Auto Answer 5: Flash/Recall 6: Incoming Log 7: Outgoing Log 8: Phonebook 9: — 0: — * : — # : —
		<b>Suffix: (none/C)</b> <input type="checkbox"/> Redial <input type="checkbox"/> Fwd/DND* <sup>1</sup> <input type="checkbox"/> Flash/Recall <input type="checkbox"/> Auto Answer <input type="checkbox"/> Conference <input type="checkbox"/> Incoming Log <input type="checkbox"/> Outgoing Log <input type="checkbox"/> Phonebook <input type="checkbox"/> Call Park* <sup>2</sup> * <sup>3</sup> <input type="checkbox"/> Intercom <input type="checkbox"/> Pause* <sup>3</sup> <input type="checkbox"/> Alarm <input type="checkbox"/> Noise Reduction/Voice Clarity* <sup>4</sup> <input type="checkbox"/> Paging* <sup>2</sup> * <sup>3</sup> <input type="checkbox"/> None	1: Redial 2: Fwd/DND* <sup>1</sup> 3: Flash/Recall 4: Auto Answer 5: Conference 6: Incoming Log 7: Outgoing Log 8: Phonebook 9: — 0: — * : — # : —
Soft Key Edit ● Softkey A ● Softkey B ● Softkey C	Edits the soft keys in the following situations. ● Standby ● Talking	<input type="checkbox"/> Default <input type="checkbox"/> Function Key <input type="checkbox"/> Hot Key Dial* <sup>5</sup>	Not stored
Soft Key Name ● Softkey A ● Softkey B ● Softkey C	Edits the names of the soft keys in the following situations. ● Standby ● Talking	Max. 5 characters	Not stored

## Appendix

Sub Item	Description	Setting	Default
Key Lock Type	Selects the type of key lock.	<input type="checkbox"/> Manual <input type="checkbox"/> Manual&Password*6*7 <input type="checkbox"/> Auto <input type="checkbox"/> Auto&Password*6*7	Manual
Auto Lock Time	Sets the number of seconds before the handset/desk phone key lock is activated when "Auto" is selected as the "Key Lock Type".	0s–60s	10s
Hot Key Time	Selects the number of seconds before a call is automatically made when a Hot Key assigned to "Auto" is pressed and held.	1s–20s	2s

\*1 "Call Forward" when connected to a base unit other than the KX-TGP600.

\*2 Not available when connected to a base unit other than the KX-TGP600.

\*3 "Call Park", "Pause" and "Paging" are displayed only when they are enabled in settings. Contact your administrator for further information.

\*4 KX-TPA60 only.

\*5 Displayed only when "Standby" is selected.

\*6 To avoid unauthorized access to this product:

- Set a password that is random and cannot be easily guessed.
- Change the password regularly.

\*7 If no password has been set, you cannot select "Manual&Password" or "Auto&Password" for "Key Lock Type". For details about setting the password, see "Setting the Password", Page 43.

## Display Option

Sub Item	Description	Setting	Default
Language	Selects the display language. Up to 10 languages can be downloaded from the base unit. The feature depends on your phone system. Contact your administrator for further information.	<b>Suffix: CE/UK/AL</b> <input type="checkbox"/> Auto <input type="checkbox"/> English <input type="checkbox"/> Deutsch <input type="checkbox"/> Español <input type="checkbox"/> FRANÇAIS <input type="checkbox"/> Italiano <input type="checkbox"/> Svenska*1 <input type="checkbox"/> Nederlands*1 <input type="checkbox"/> Português*1 <input type="checkbox"/> Čeština	Auto
		<b>Suffix: (none/C)</b> <input type="checkbox"/> Auto <input type="checkbox"/> English <input type="checkbox"/> Español <input type="checkbox"/> FRANÇAIS	Auto
		<b>Suffix: RU</b> <input type="checkbox"/> Auto <input type="checkbox"/> English <input type="checkbox"/> РУССКИЙ <input type="checkbox"/> Українська	Auto
		<b>Suffix: LA/LC</b> <input type="checkbox"/> Auto <input type="checkbox"/> English <input type="checkbox"/> Español <input type="checkbox"/> Português	Auto
Backlight	Turns on the backlight of the LCD and keypad*2. Can be set for each of the following: <ul style="list-style-type: none"> <li>● Receiving</li> <li>● Talking</li> <li>● Standby (KX-TPA65 only)</li> </ul>	<input type="checkbox"/> On <input type="checkbox"/> Off	Receiving: Off Talking: On Standby: On
LCD Brightness	Adjusts the brightness of the backlight of the LCD.	Level 1–6	Level 3
Standby Display*3	Selects what is shown on the display while in standby mode.	<input type="checkbox"/> Handset Name <input type="checkbox"/> Phone Number <input type="checkbox"/> Phone No&Name <input type="checkbox"/> Off	Handset Name
Handset Name	Edits the name displayed on the LCD while in standby mode.	Max. 16 characters	Handset y (y: Handset number)
Category Name	Edits the names of the categories.	Max. 13 characters x Category (1–9)	Not stored

## Appendix

Sub Item	Description	Setting	Default
Date Format	Selects the format for the date shown on the display in standby mode.	<input type="checkbox"/> DD-MM-YYYY <input type="checkbox"/> MM-DD-YYYY <input type="checkbox"/> YYYY-MM-DD	Suffix: CE/UK/ AL/LA/LC/RU DD-MM-YYYY
			Suffix: (none/C) MM-DD-YYYY
Time Format	Selects the format for the time shown on the display in standby mode.	<input type="checkbox"/> 12H <input type="checkbox"/> 24H	Suffix: CE/UK/ AL/LA/LC/RU 24H
			Suffix: (none/C) 12H
Caller ID Disp	Selects which caller information is displayed when a call is received. Either the information stored in the Handset Phonebook or the network can be displayed.	<input type="checkbox"/> H/S Phonebook <input type="checkbox"/> Network	Network
Colour Scheme/ Color Scheme	Selects the color scheme of the LCD.	<input type="checkbox"/> Dark <input type="checkbox"/> Light	Dark
Base Monitor	Selects the base number display mode in the maintenance mode.	<input type="checkbox"/> Off <input type="checkbox"/> Current Base <input type="checkbox"/> Current+Scanned	Off

\*1 Cannot be selected when connected to a base unit other than the KX-TGP600.

\*2 The keypad backlight is available only for the KX-TPA60.

\*3 Not displayed when connected to a base unit other than the KX-TGP600.

### Tone Option

Sub Item	Description	Setting	Default
Key Tone	Turns the key tone on or off.	<input type="checkbox"/> On <input type="checkbox"/> Off	On
Range Alarm	Selects whether the range alarm tone rings or not.	<input type="checkbox"/> On <input type="checkbox"/> Off	On

### System Option

Sub Item	Description	Setting	Default
Register H/S	Registers a handset/desk phone to a base.	Base 1–4	Not stored
Cancel Base* <sup>1</sup>	Cancels the registration of a handset/desk phone.	Base 1–4* <sup>2</sup>	Not selected
Select Base* <sup>1</sup>	Selects a base.	<input type="checkbox"/> Auto <input type="checkbox"/> Base 1–4	Auto
System Lock	Selects whether to lock the System Option setting or not.	<input type="checkbox"/> On* <sup>3</sup> <input type="checkbox"/> Off	Off



Sub Item	Description	Setting	Default
Change PIN	Before registering your handset/desk phone with a base unit, enter the base unit's PIN here. Once you have registered the handset/desk phone with a base unit, this PIN can be changed so that the handset/desk phone can be registered to an additional base unit.	Enter the PIN number. (max. 8 digits)	1234
H/S Information	Displays the firmware version.	—	—

\*1 Only registered bases are shown.

\*2 You can select multiple bases simultaneously.

\*3 Password is required (4 digits). For details about setting the password, contact your administrator.

### Other Option

Sub Item	Description	Setting	Default
Change Password*1*2	Changes the handset/desk phone password (4 digits) used for unlocking the Handset Phonebook, using the "Reset Handset" option, and unlocking the key lock.	Enter Old Password.*3 ↓ Enter New Password. ↓ Verify New Password.	Not registered
Reset Handset	Returns the handset/desk phone settings to its default settings.	Enter Password. (4 digits)*4 ↓ Select the desired item(s). ↓ Press <b>OK</b> .	Not selected
Embedded Web*5	Selects whether the web function/the logging is available or not.	<input type="checkbox"/> On <input type="checkbox"/> Off	Off

\*1 To avoid unauthorized access to this product:

- Set a password that is random and cannot be easily guessed.
- Change the password regularly.

\*2 Make a note of the password so that you will not forget it.

\*3 If a password has not already been set, you can skip the first step.

\*4 For details about setting the password, see "Setting the Password", Page 43.

\*5 Not displayed when connected to a base unit other than the KX-TGP600.

**System Setting Menu Layout (when connected to the KX-TGP600)**

**Status**

Sub Item	Description	Setting	Default
Line Status	Displays the line status.	Registered/Registering/ (NULL)	—
Firmware Version	Selects which is shown on the display the model number and the firmware version.	–Base Station –Handset	—
IP Mode	Displays the IP network mode.	IPv4/IPv6/IPv4&IPv6	—
IPv4 Settings	Displays the information about IPv4 settings.	–IP Address*1 –Subnet Mask*1 –Default Gateway*1 –DNS*1	—
IPv6 Settings	Displays the information about IPv6 settings.	–IP Address*2 –Prefix*2 –Default Gateway*2 –DNS*2	—
MAC Address	Displays the MAC address of the base unit.	—	—
LLDP	Display LLDP status.	On/Off	—
VLAN	Display VLAN ID and priority.	—	—

\*1 If this item is not set, "0.0.0.0" is displayed. If the base unit does not connect to the Ethernet, "... " is displayed.

\*2 If this item is not set, "0::0" is displayed. If the base unit does not connect to the Ethernet, "::" is displayed.

**Network Settings**

Sub Item	Description	Setting	Default
IP Mode Select	Changes the network settings of the base unit. Current settings are displayed as a highlight.	–IPv4 –IPv6 –IPv4&IPv6	IPv4
IPv4 Settings	Specifies the IPv4 settings.	<input type="checkbox"/> DHCP <input type="checkbox"/> Auto <input type="checkbox"/> Manual –DNS 1 –DNS 2 <input type="checkbox"/> Static –IP Address –Subnet Mask –Default Gateway –DNS 1 –DNS 2	DHCP–Auto

Sub Item	Description	Setting	Default
IPv6 Settings	Specifies the IPv6 settings.	<input type="checkbox"/> DHCP <input type="checkbox"/> Auto <input type="checkbox"/> Manual –DNS 1 –DNS 2 <input type="checkbox"/> RA –DNS 1 –DNS 2 <input type="checkbox"/> Static –IP Address –Prefix –Default Gateway –DNS 1 –DNS 2	DHCP–Auto
LLDP	Specifies the LLDP settings.	<input type="checkbox"/> On <input type="checkbox"/> Off	On
VLAN	Specifies the VLAN settings.	Enable VLAN <input type="checkbox"/> Yes <input type="checkbox"/> No VLAN ID: 0–4094 VLAN Priority: 0–7	Enable VLAN: No VLAN ID: 2 VLAN Priority: 7
Link Speed	Specifies the Ethernet PHY mode settings.	<input type="checkbox"/> Auto <input type="checkbox"/> 100M/Full <input type="checkbox"/> 100M/Half <input type="checkbox"/> 10M/Full <input type="checkbox"/> 10M/Half	Auto

### System Settings

Sub Item	Description	Setting	Default
Register H/S	Registers the handset/desk phone selected from the list to the base unit currently connected.	Select the handset/desk phone.	—
Cancel Register	Cancels the handset/desk phone registration between the handset/desk phone and the base unit.	Select the handset/desk phone.	—
Change Base PIN	Changes the PIN (4 digits) of the base unit.	Enter PIN ↓ Enter New PIN ↓ Verify New PIN	1234
Set Time & Date <sup>*1</sup>	Specifies the time and date of the handset/desk phone.	—	—
Repeater Mode	Selects whether or not to use the repeater.	<input type="checkbox"/> On <input type="checkbox"/> Off	Off

## Appendix

Sub Item	Description	Setting	Default
MultilineSetting	Specifies the multiline mode.	<input type="checkbox"/> Incoming Call* <sup>2</sup> <input type="checkbox"/> Line 1–8 <input type="checkbox"/> Handset 1–8 <input type="checkbox"/> Outgoing Call* <sup>3</sup> <input type="checkbox"/> Handset 1–8 <input type="checkbox"/> Line 1–8 <input type="checkbox"/> Default Line* <sup>4</sup>	Incoming Call: Handset 1–8 Outgoing Call: Line 1–8 Default Line: Line 1
Authentication* <sup>5</sup>	Specifies the ID and password for HTTP authentication.	–ID* <sup>5</sup> –Password* <sup>5</sup>	Not stored
Access Code* <sup>6</sup>	Specifies the access code to access the redirect server.	Max. 16 characters	Not stored
Xsi Setting* <sup>7</sup>	Specifies the ID and password for the Xsi service.	Line 1–8 ID* <sup>5</sup> Password* <sup>5</sup>	Not stored
UC Setting* <sup>7</sup>	Specifies the ID and password for the Broadsoft UC service (IM&P).	Handset 1–8 ID* <sup>5</sup> Password* <sup>5</sup>	Not stored
Parallel Setting (KX-TPA65 only)	Register/deregister the paired handset of the desk phone.	Master Handset <input type="checkbox"/> Pairing* <sup>8</sup> <input type="checkbox"/> Mode <input type="checkbox"/> Busy <input type="checkbox"/> Take Over Call	Pairing: Off

\*1 Availability depends on your phone system. Contact your administrator for further information.

\*2 After selecting the line, selects the handset(s)/desk phone(s) assigned to the line.

This function is enabled by default for all handsets/desk phones.

\*3 After selecting the handset/desk phone, selects the line(s) assigned to the handset/desk phone.

This function is enabled by default for all handsets/desk phones.

\*4 After selecting the handset/desk phone, selects a default line assigned to the handset/desk phone.

\*5 Max. 128 characters

\*6 This item is displayed only during initial setup.

\*7 If the Xsi service is available, you can select these items. Contact your administrator for further information.

\*8 If a handset and a desk phone have already been paired, the handset is highlighted.

### Call Settings

Sub Item	Description	Setting	Default
Block Anonymous	Specifies whether or not to block incoming anonymous calls.	Line 1–8 <input type="checkbox"/> On <input type="checkbox"/> Off	Off
Anonymous Call	Specifies whether or not to make outgoing anonymous calls.	Line 1–8 <input type="checkbox"/> On <input type="checkbox"/> Off	Off
Block Caller ID	Edits/deletes the phone numbers to reject incoming calls.	Line 1–8 –Edit –Delete Number –Delete All No.	Not stored

Sub Item	Description	Setting	Default
Anywhere*3	Specifies/edits the Xsi's Anywhere settings.	–Anywhere*1 <input type="checkbox"/> On <input type="checkbox"/> Off –Name –Phone Number*2	—
Remote Office*3	Specifies the Xsi's Remote Office setting.	–Remote Office <input type="checkbox"/> On <input type="checkbox"/> Off –Phone Number*2	—
SimultaneousRing*3	Specifies the Xsi's Simultaneous Ring setting.	–SimultaneousRing <input type="checkbox"/> On <input type="checkbox"/> Off –Phone Number*2	

\*1 Displayed only when editing.

\*2 In a phone number that exceeds 32 digits, the exceeding digits will not be displayed.

\*3 If the Xsi's service is available, you can select these items. Contact your administrator for further information.

## System Setting Menu Layout (when connected to a base unit other than the KX-TGP600)

### System Settings

Sub Item	Description	Setting	Default
Change Base PIN	Changes the PIN (8 digits) of the base unit.	Enter PIN ↓ Enter New PIN ↓ Verify Enter PIN	—
Set Time & Date*1	Specifies the time and date of the handset.	—	—
Base Reset	Resets the base unit settings.	—	—
Base Version	Displays the base unit version.	—	—
Line Setting	Specifies line settings.	–Line Name*2 –Attached Handset –Multicall Mode <input type="checkbox"/> On <input type="checkbox"/> Off	—
Intercom List	Sets intercom lists.	–Name*2 –Interception <input type="checkbox"/> On <input type="checkbox"/> Off –Delete	—

\*1 Availability depends on your phone system. Contact your administrator for further information.

\*2 Max. 16 characters

### Specifications

#### KX-TGP600 (Suffix: all)

Item	Specifications
Power Supply	AC adaptor/PoE (IEEE 802.3af)
Maximum Power Consumption	2.6 W
Operating Environment	0 °C (32 °F) to 40 °C (104 °F)
Ethernet Port (LAN)	1 (RJ45)
Ethernet Interface	10Base-T/100Base-TX (Auto/100MB-FULL/100MB-HALF/10MB-FULL/10MB-HALF)
CAT-iq	2.0
Wideband Codec	G.722/G.722.2
Narrowband Codec	G.711a-law/G.711 $\mu$ -law/G.729a
Multiple Line	8
Multiple Handset/Desk Phone	8
Simultaneous Voice Calls (Narrowband Mode)	Talk 8 + Conference 2
Simultaneous Voice Calls (Wideband Mode)	Talk 4 + Conference 2 (AMR-WB : Talk 2)
Dimensions (Width × Depth × Height)	118.7 mm × 45.0 mm × 88.1 mm (4.67 in × 1.77 in × 3.47 in)
Weight	126 g (0.28 lb)

#### KX-TPA60/KX-TPA65

Item	KX-TPA60	KX-TPA65
Power Supply	—	AC adaptor
Maximum Power Consumption	1.6 W	1.52 W
Operating Environment	0 °C (32 °F) to 40 °C (104 °F)	0 °C (32 °F) to 40 °C (104 °F)
CAT-iq	2.0	2.0
Key Backlight	Yes (White)	No
Strap Hole	Yes	—
Belt Clip	Yes	—
Display	1.8-inch TFT Backlight LCD, 65,000 colors	1.8-inch TFT Backlight LCD, 65,000 colors
Headset Jack	1 (ø 2.5 mm [3/32 in])	1 (ø 2.5 mm [3/32 in])
Batteries	Ni-MH AAA × 2 (1.2 V, 630 mAh)	—
Battery Performance	Talk: up to 11 hours Standby: up to 200 hours	—
Charging Time	6 hours	—



Dimensions (Width × Depth × Height)	47.8 mm × 25.5 mm × 153.2 mm (1.88 in × 1.00 in × 6.03 in)	"High" position: 192 mm × 170 mm × 182 mm (7.56 in × 6.69 in × 7.17 in) "Low" position: 192 mm × 185 mm × 150 mm (7.56 in × 7.28 in × 5.91 in)
Weight	117 g (0.26 lb)	675 g (1.49 lb)

## RF Specifications

### KX-TGP600/KX-TPA60/KX-TPA65

Item	USA, Canada	Latin America	Other countries/areas
Wireless Interface	DECT 6.0	DECT	DECT
Frequency Band	1920 MHz to 1930 MHz	1910 MHz to 1920 MHz	1880 MHz to 1900 MHz
Number of Carriers	5	5	10
Transmission Output	Peak 111 mW	Peak 250 mW	Peak 250 mW

Troubleshooting

Problem	Possible Cause	Solution
The handset does not work.	The battery is drained.	Charge the battery fully. For details, see "Charging the Batteries" on Page 82.
	The power is off.	<ul style="list-style-type: none"> <li>Turn it on. For details, see "Location of Controls" on Page 18.</li> <li>Re-insert the battery, and then set the handset on the charger. For details, see "Battery Installation" on Page 82, and "Charging the Batteries" on Page 82.</li> </ul>
The handset/desk phone does not ring.	Ringer volume is set to "Off". (If the ringer volume is set to "Off",  is displayed.)	Adjust the ringer volume level. See "Adjusting the Volume" on Page 40.
	Silent Mode is on. (If Silent Mode is on, the icon  is displayed.)	Turn off Silent Mode. For details, see "Silent Mode" on Page 54.
It is difficult to have a conversation when in Hands-free mode.	The microphone is facing the wrong direction or is obstructed during the conversation.	The front of the handset should face you, and the microphone should not be covered. For details, see "Location of Controls" on Page 18.
You cannot make/receive a call.	The handset is out of range, or the base unit is busy.	Move closer to the base unit or try again later.
	The radio channel is busy, or a radio communication error occurred.	Try again later.
You cannot dial.	The number that you dialed is restricted by your phone system.	Consult your administrator or your phone system dealer/service provider.
	Key lock mode is on.	To cancel the mode, press and hold  for about 2 seconds. For details, see "Key Lock" on Page 43.
	The radio channel is busy or a radio communication error occurred.	Try again later.



Problem	Possible Cause	Solution
The handset stops working during operation.	An unknown error has occurred.	<ul style="list-style-type: none"> <li>● Turn the handset off, and then turn it back on. For details, see "Location of Controls" on Page 18.</li> <li>● Re-insert the battery and try again. For details, see "Battery Installation" on Page 82.</li> </ul>
You cannot use the handset/desk phone during a power failure.	The handset/desk phone will not function during a power failure because the base unit stops emitting radio waves.	—
The headset does not work.	A headset tone cannot be heard when receiving an incoming call when the headset is attached.	<ul style="list-style-type: none"> <li>● Make sure the headset tone setting is set to "On". See "Incoming Option" on Page 91.</li> <li>● Make sure the headset jack is connected properly. See "Location of Controls" on Page 18.</li> </ul>
Noise is frequently heard.	Nearby electrical appliances are causing interference, or you are too far from the base unit.	<ul style="list-style-type: none"> <li>● Place the handset/desk phone and base unit away from other electrical appliances.</li> <li>● Move closer to the base unit.</li> </ul>
Two short beeps are heard during a conversation.	The radio signal is weak.	Move closer to the base unit.
The charge indicator flashes red rapidly.	The charger is not connected properly.	<ul style="list-style-type: none"> <li>● Make sure the battery is inserted properly.</li> <li>● Set the handset in the charger properly.</li> <li>● Contact your phone system dealer/service provider.</li> </ul>
You charged the batteries for 6 hours, but the beep tones sound, and  (needs to be charged) flashes after a few telephone calls.	The battery charge contacts may be dirty.	Clean the battery charge contacts without damaging them and charge once more.
	It is time to change the batteries.	Replace with a new one.
While charging the battery, the handset and the AC adaptor feel warm.	These are normal conditions.	—
"No Service" is displayed, and beep tones are heard.	The handset/desk phone is out of range.	Move closer to the base unit or try again later.
	The base unit or Server is out of service.	Contact your phone system dealer/service provider.

## Appendix

Problem	Possible Cause	Solution
While charging the battery, the LED indicator blinks rapidly, but the handset does not beep.	The temperature of the battery being charged is outside of normal limits.	Confirm that the area where the handset is being charged is between 5 °C (41 °F) and 40 °C (104 °F), and wait for the battery's temperature to drop.
While charging the battery, the LED indicator blinks rapidly and the handset beeps rapidly.	The battery is not charging correctly due to an electrical failure.	Unplug the AC adaptor from the AC outlet, remove the battery from the handset, and contact your phone system dealer/service provider.
	A wrong type of battery such as Alkaline or Manganese was inserted.	Use only the rechargeable Ni-MH batteries noted on Page 11, 12.
I cannot remember the PIN number.	—	Contact your phone system dealer/service provider.
The "Delete All" operation to delete all phonebook entries is not functioning.	Batteries are drained, which prevents the operation from being completed.	Charge the battery fully, and then try again. For details, see "Charging the Batteries" on Page 82.

## Error Messages

Error Message	Possible Cause	Solution
Register Unit	The handset/desk phone has been cancelled or the handset/desk phone has not been registered.	Consult your dealer.
No Service	The handset/desk phone is out of range.	Move closer to the base unit.
	The base unit is turned off.	Make sure the power cord is connected.
Invalid	The called party on an intercom call is rejecting your calls.	Wait a moment and try again.
Path Busy	The base unit is busy.	Try again later.
Please Wait...	The handset/desk phone is connecting to the base unit or Server.	Wait for a moment.
Charge Battery	The handset battery has little charge remaining.	Charge the battery fully. See "Charging the Batteries" on Page 82.
No Entries	When trying to view the Phonebook: No items have been stored. See "Storing an Item in the Handset Phonebook" on Page 63. When trying to view the Incoming or Outgoing Call Log: No logs have been stored.	
Memory Full	The Phonebook is full and cannot store the new item.	Remove unnecessary data in the Phonebook and try again.
Need Repair		Contact your phone system dealer/service provider.
Not Found	The handset/desk phone does not answer when a call is made.	The handset/desk phone is out of range or turned off.
Aborted	There was a wireless transmission error during a phonebook download or upload.	Use the handset/desk phone closer to the base unit.
Phonebook Error	There was a wireless transmission error, corrupted data, or the memory became full during a phonebook download.	<ul style="list-style-type: none"> <li>● Remove unnecessary data in the phonebook, or consult your administrator regarding the number of items being downloaded.</li> <li>● Use the handset/desk phone closer to the base unit.</li> <li>● This message disappears if you access the phonebook.</li> </ul>

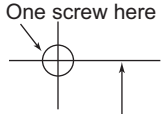

55 mm  
(2 5/32 in)  
for KX-TGP600

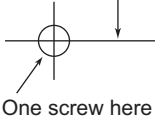

### WALL MOUNTING TEMPLATE

1. Drive the screws into the wall as indicated.
2. Hook the unit onto the screw heads.

**Note:**

Make sure to set the print size to correspond with the size of this page. If the dimensions of the paper output still deviate slightly from the measurements indicated here, use the measurements indicated here.

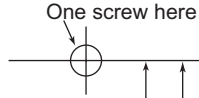

100 mm (3 15/16 in)  
83 mm (3 1/4 in)

for KX-TPA65

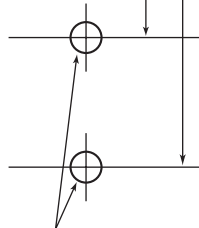

One screw at either point







## **Panasonic System Networks Co., Ltd.**

1-62, 4-chome, Minoshima, Hakata-ku, Fukuoka 812-8531, Japan

Web Site: <http://www.panasonic.net/pcc/support/sipphone/>

## **Panasonic Corporation of North America**

Two Riverfront Plaza, Newark, NJ 07102-5490

Web Site: <http://www.panasonic.net/pcc/support/sipphone/>

## **Panasonic Canada Inc.**

5770 Ambler Drive, Mississauga, Ontario, L4W 2T3

Web Site: <http://www.panasonic.ca>

### Copyright:

This material is copyrighted by Panasonic System Networks Co., Ltd., and may be reproduced for internal use only. All other reproduction, in whole or in part, is prohibited without the written consent of Panasonic System Networks Co., Ltd.